

*Leitz*  
WETZLAR

# ORTHOLUX

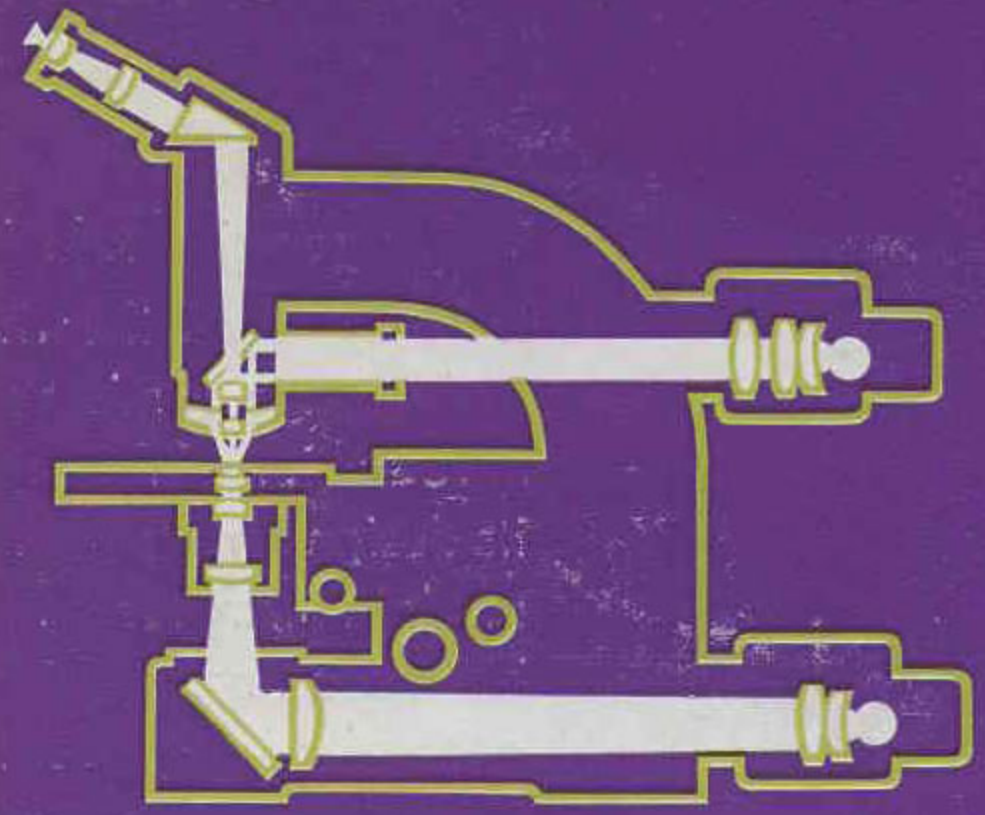

Large Research Microscope  
**ORTHOLUX**  
for the application  
of all methods  
of microscopic examination



ERNST LEITZ GMBH WETZLAR

51<sub>2</sub>-40b/Engl.

## The large universal microscope ORTHOLUX®

is the stand with the widest field of application and versatility in the range of microscopes produced by us. Through the introduction of the principle of the built-in source of light, its design has paved the way for the development of the modern microscope.

The advantages of a built-in source of light are today generally recognized: it renders microscopy independent of the fluctuating conditions of daylight, ensures constant readiness of the instrument, gives optimum light guidance, and greatly simplifies the application of the more refined methods of examination, such as phase contrast microscopy.

The ORTHOLUX possesses separate sources of light for transmitted and incident illumination. It is thus possible to alternate between these two types of illumination at will or – without additional sources of light – to use a combination of transmitted and incident light with full exploitation of the individually controlled brilliance in the two beam paths.

Spectral lamps or a monochromator attachment can be easily interchanged with the lamp housing of the built-in illumination. The sources of light are insulated from the microscope stand in such a manner that no heat conduction to the focusing mechanisms can take place. Through the introduction of the built-in sources of light, it was possible to submit the traditional shape of the microscope to a critical investigation, and to follow a new course in the structural design of the ORTHOLUX stand. The main feature here is the support for the tube, revolving objective nosepiece, stage and condenser, which curves away from the observer. This design permits a most convenient position for all the controls.

® = Registered Trade Mark

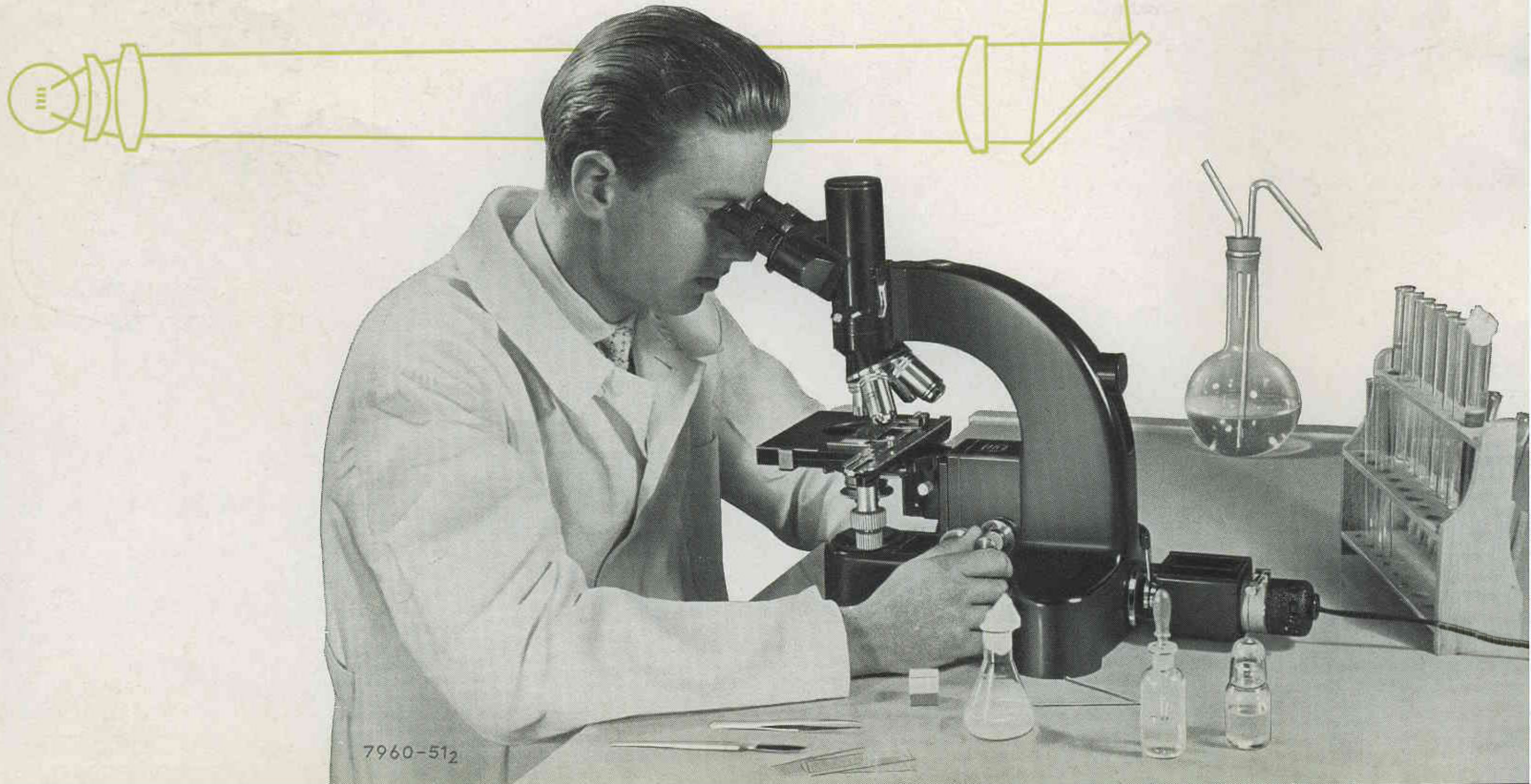
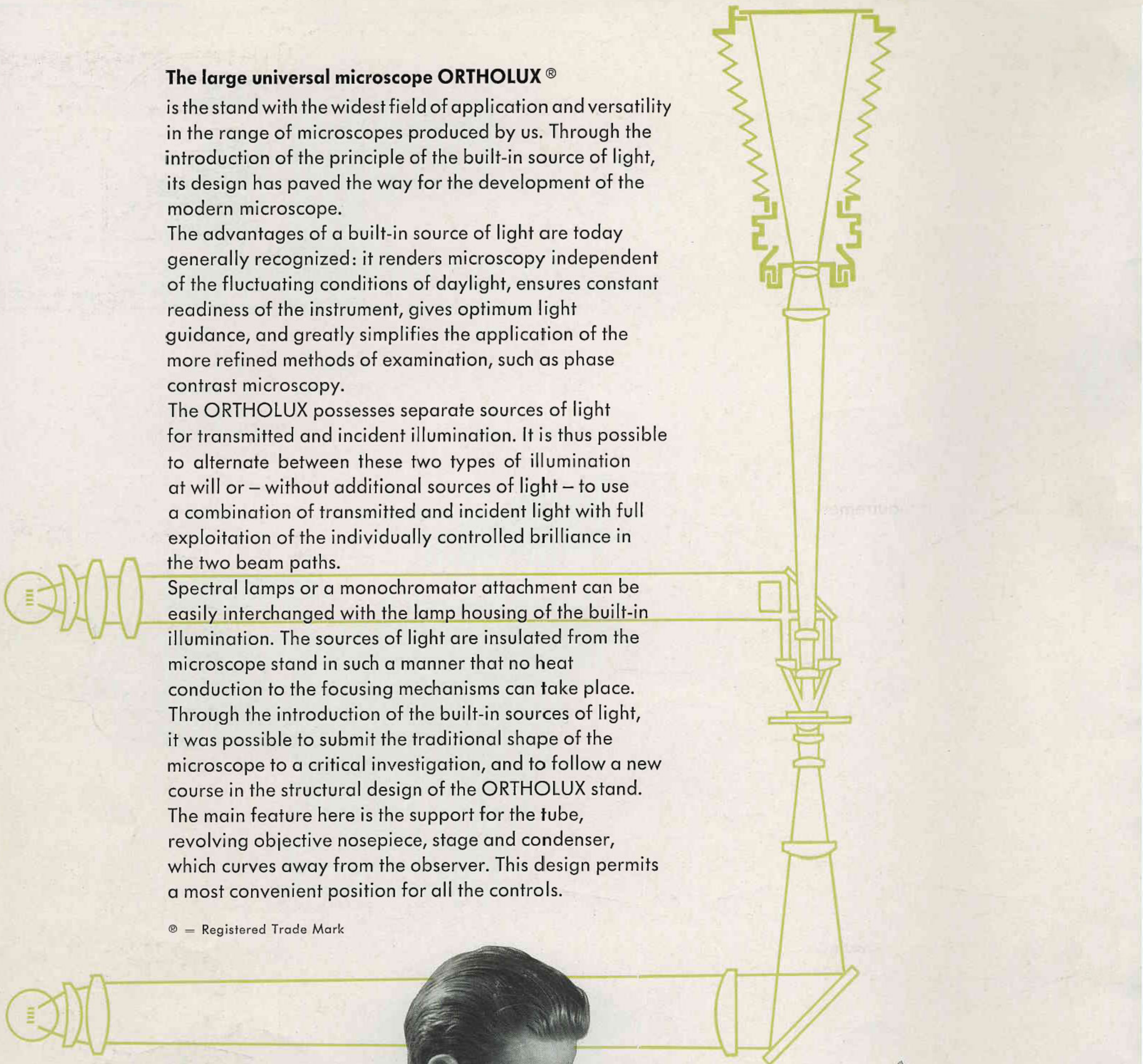

But in particular, through this design the object stage with the specimen is freely accessible from the operating position, and can be seen in its entirety without obstruction. The height and inclination of the eyepiece tubes have been chosen in such a manner that observers, no matter how tall they are, can use the instrument without suffering fatigue and with the body in a comfortable position.

The low-set controls for coarse and fine focusing act on the object stage and can be operated on the left or right. Thus fine focusing is independent of additional weight on the tube or the upper section of the microscope through heavy supplementary attachments. The controls for the cross motion of the object stage and the condenser are situated at about the same height.

Through these arrangements, the stand offers a degree of spaciousness which is most welcome when working with supplementary microscopic attachments. It is possible not only to change the actual components of the microscope according to the particular requirements (i. e. tube, revolving objective nosepiece, stage and condenser), but also to use the ORTHOLUX in combination with supplementary attachments such as a heating stage, an integrating stage for planimetric analysis, or a microscope photometer. By this method, once an ORTHOLUX stand has been purchased in the first instance, it can be supplemented subsequently as required in order to perform special research duties.

There is also a versatile range of possibilities in the field of photomicrography. In view of its design, the ORTHOLUX microscope offers particularly favourable conditions for photomicrography, since the photomicrograph can be taken without deflection of the image forming beams. This point is of special importance, because additional reflecting surfaces in the image forming path of light can cause a deterioration in the image quality, and also require special maintenance (dust). A direct, non-deflected beam path also permits the shortest exposure times, since there is no loss of light through reflection. A notable feature is that the supplementary attachments for photomicrography do not detract from the character of the microscope as a convenient table instrument.

In this connection, reference must be made also to the micro electronic flash Mikroblitz 300, which has been specially designed for use with the ORTHOLUX. This attachment has considerably extended the possibilities of photomicrography. Since the flash only lasts about 1/1000th of a second, it is now possible to photograph moving specimens at high magnifications in transmitted or incident light, without the restrictions hitherto applicable. For determining the exposure time for general photomicrography, and also when using the Mikroblitz 300, the MICROSIX exposure meter with its wide measuring range is to be recommended. Its use is particularly advantageous for colour photomicrography.

The examples of ORTHOLUX stand shown here represent a selection of typical outfits and supplementary equipment. Additional information will be gladly furnished on request. In particular, we shall be pleased to recommend outfits for special purposes, and to submit an estimate without obligation.

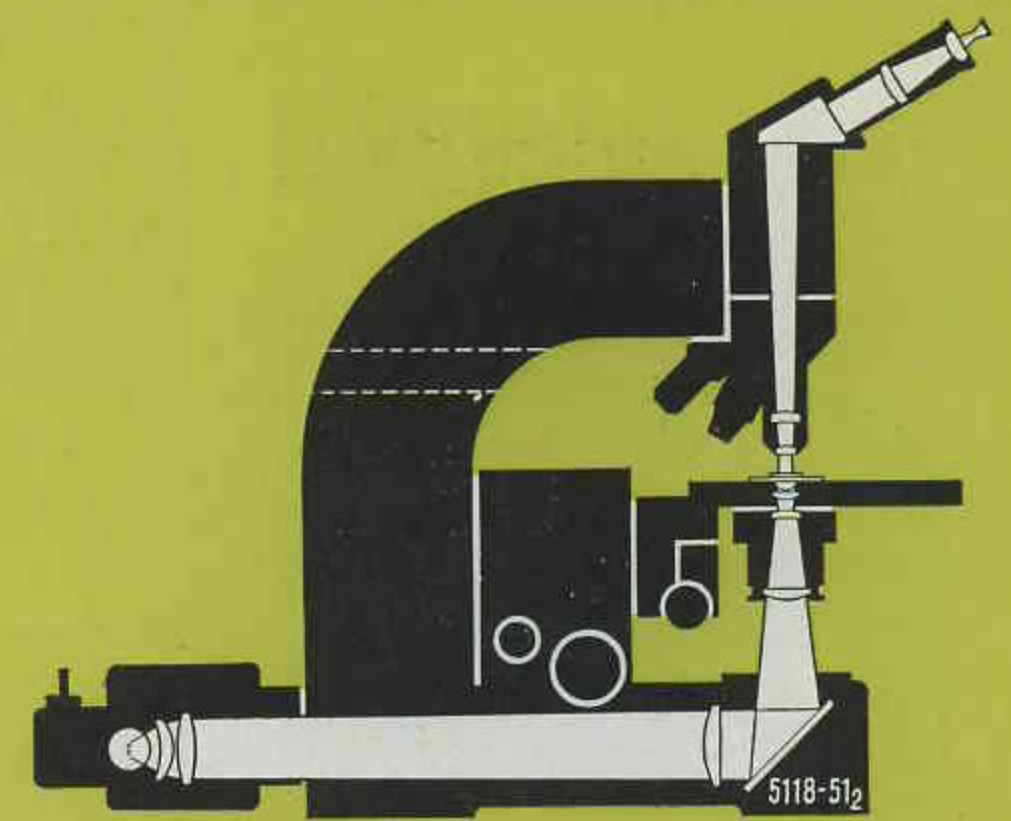

Beam path with transmitted light

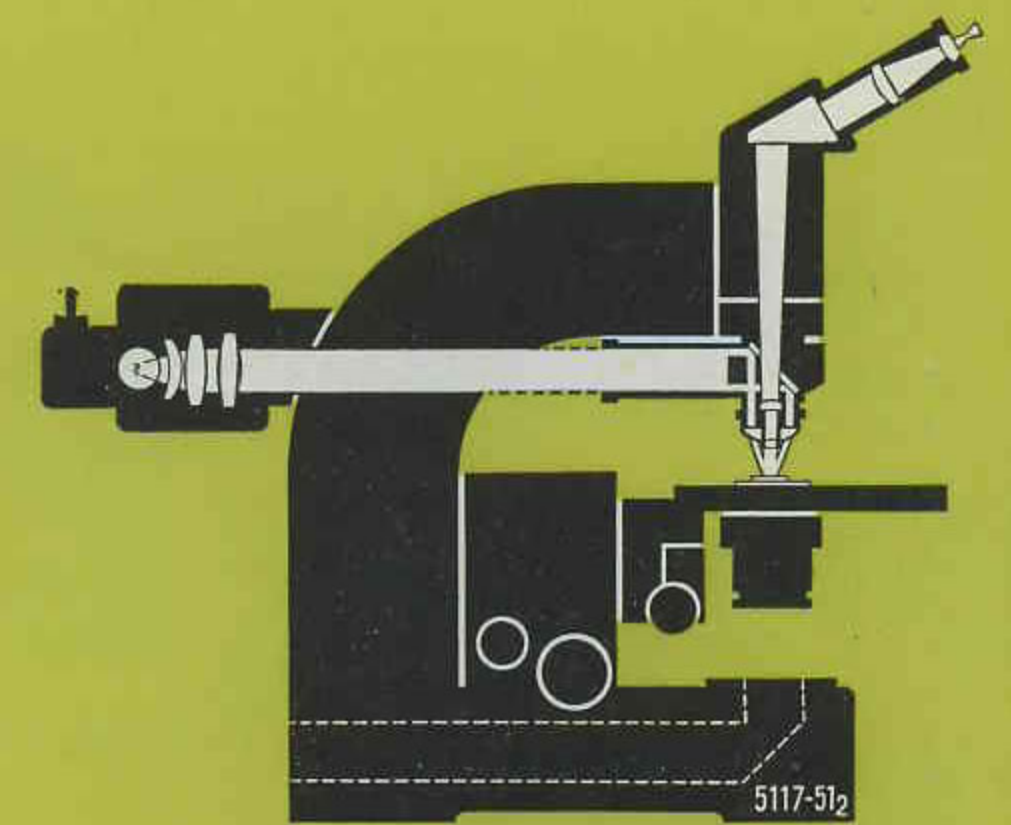

Beam path with incident light

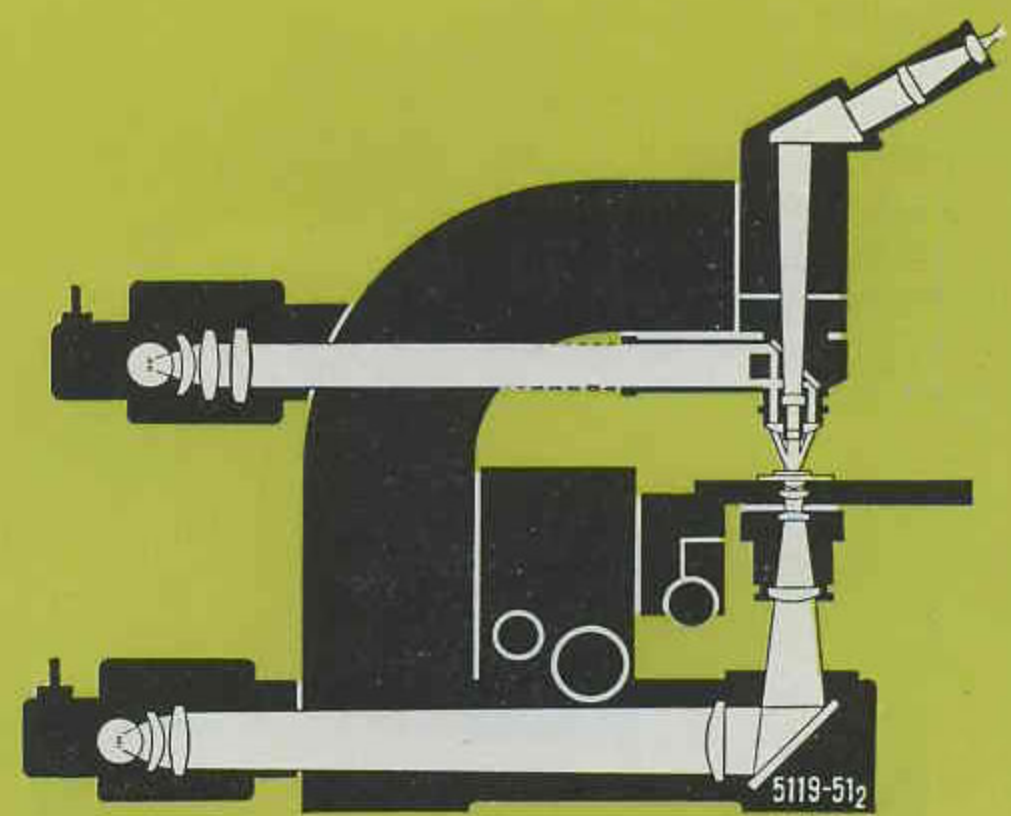

Beam path with combined transmitted and incident light



## Sources of Light

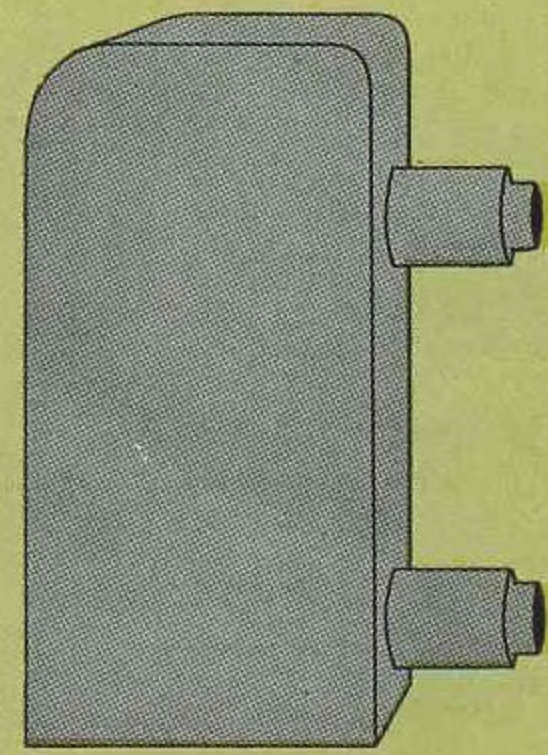

Fluorescence twin lamp  
LUORT-LUOMP



6 volt, 30 watts lamp attachment  
OLTUB



6 volt, 30 watts lamp attachment  
EYMZE

## Built-in illumination

with separate sources of light (6 volts, 30 watts) for transmitted and incident light; adjustable brilliance, high intensity; adequate reserve of power for photomicrography in black and white and colour. Special sources of light for particular purposes, including spectral lamps and the high-intensity LEITZ monochromator can also be used.

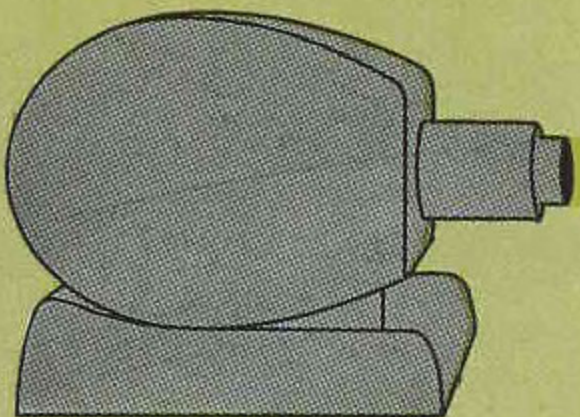

Fluorescence lamp LUNIL

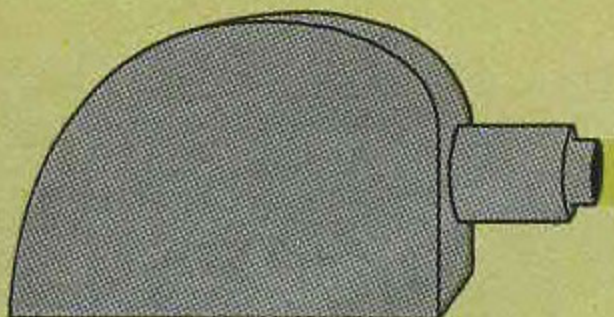

Xenon lamp LAZAZ



## Micrometer fine focusing

and coarse focusing along special ball-races; more insensitive to temperature and load, more reliable, more accurate and easy motion.

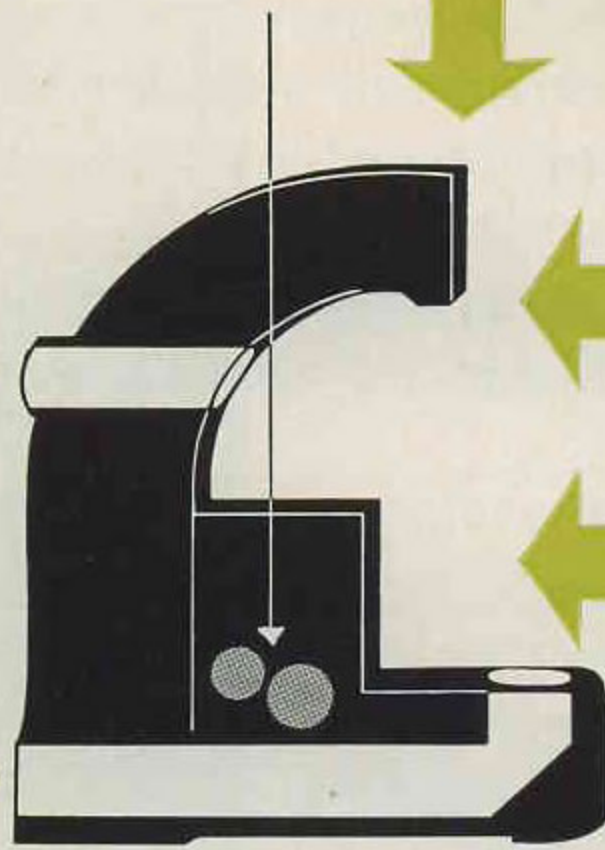

ORTHOLUX stand

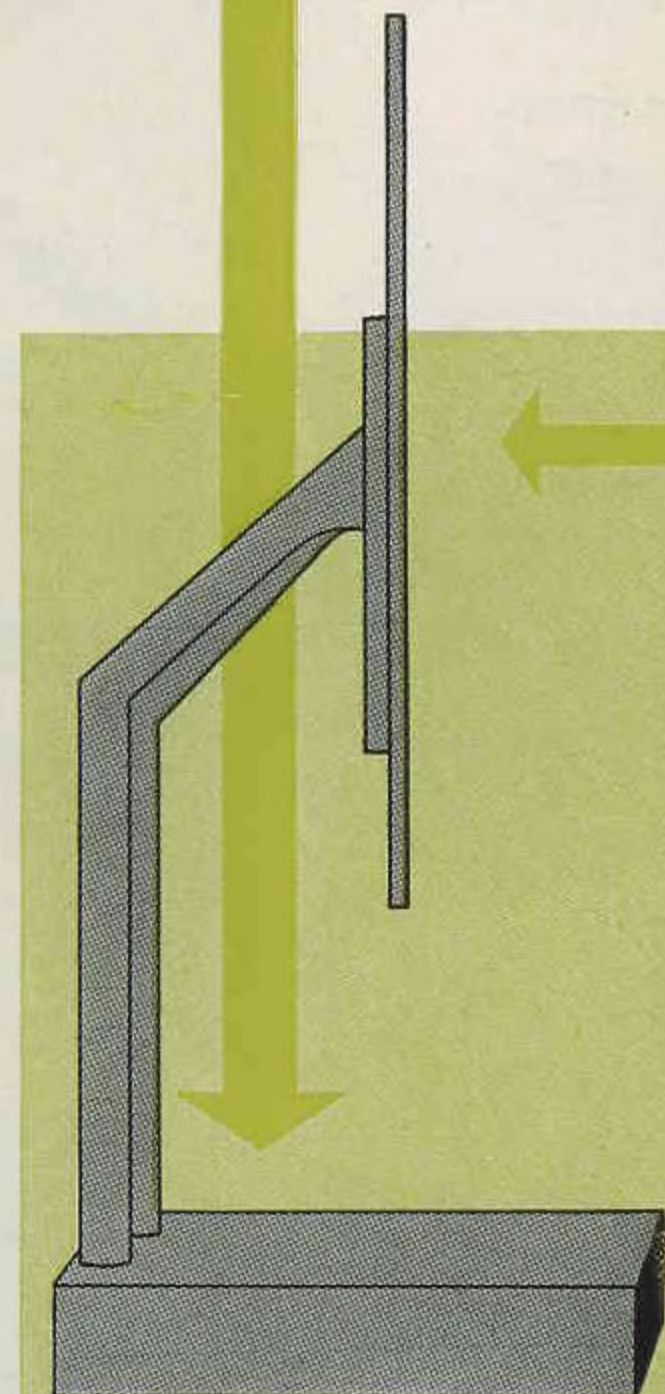

Aristophot basic stand MADAH

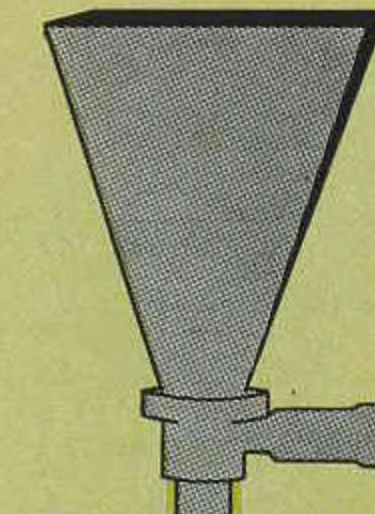

Camera attachment  
MAKAM

## Camera attachments

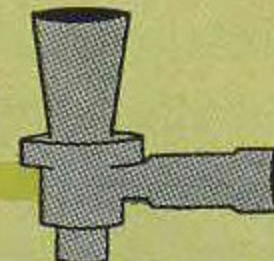

Micro attachment  
(without Leica)  
MIKAS

## Bench-top and wall projection

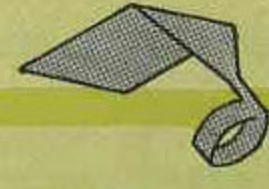

Drawing mirror  
PIIGL



Projecting prism  
PRIAU

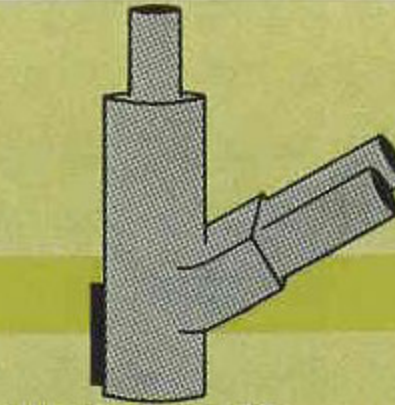

Photo tube FS  
OIYEE

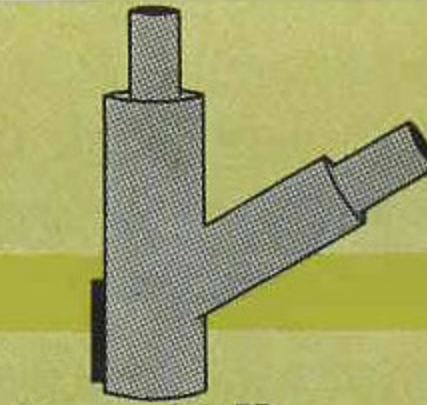
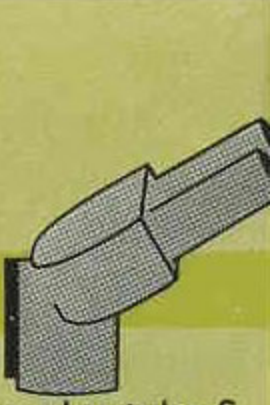

Photo tube FP  
OYED



Monocular tube O  
ORFOT



Binocular tube S  
ORSEH



Normal objectives  
for transmitted light



Quadruple revolving objective  
nosepiece ORKAT for plano objectives  
and phase contrast objectives



Fluorescence  
objectives

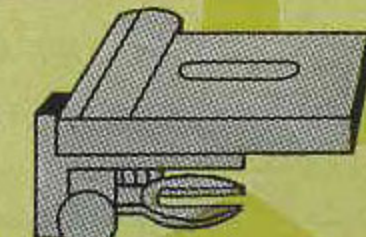

Mechanical stage No. 250  
IDKII-OZARB

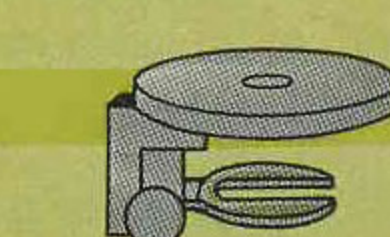

Revolving stage No. 223  
IDIRF-OZARB



Heating stage "80" HEDAD  
Heating stage "350" HEBOF



Two-diaphragm  
bright-field  
condenser No. 76  
ORBER



Dark-field condensers  
No. 82 D 1.20 A ORCIX  
No. 84 D 0.80 OREBK



Phase contrast  
condenser No. 74  
PFAHT



Fluorescence  
condenser  
IKOPY



Variocolor  
LUXOW-LUYAT



Fluorescence cooling trough  
LUNO



9x12 cm camera  
MADIK-ORHAL-PIIAH

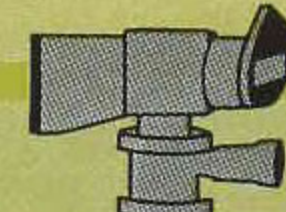

Mirror reflex attachment for the  
Leica for photomicrography  
IFLEX-M-EEXRL-ZOIII-ZOCII

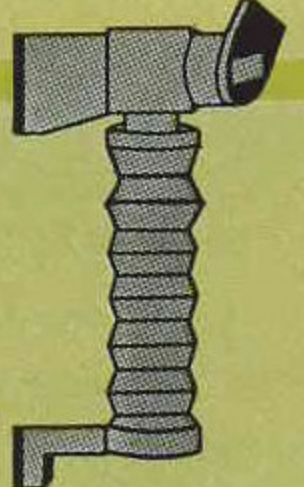

Mirror reflex attachment  
for Leica for macro-  
photography IFLEX-M  
EEXRL-EEXSN-ORHAL

Photographic objectives  
PHOTAR, SUMMAR and MILAR



## ARISTOPHOT® Universal Photographic Outfit

# The ORTHOLUX and its versatile equipment for work in transmitted and incident light

## Polarized light

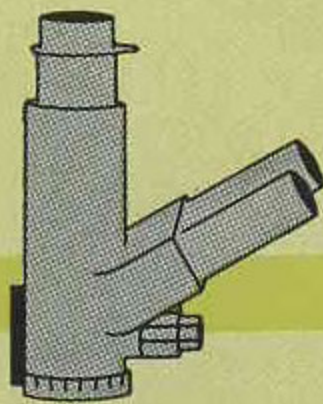

Pol. photo tube FS 45  
IIXAD



Objective centring clutch  
(without objective)  
PEZAX



Revolving objective nosepiece with centring arrangement  
(without objectives)  
PEZIZ

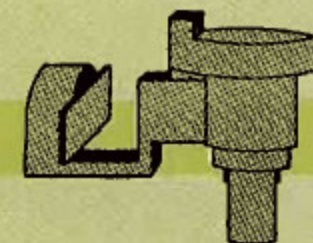

Polarizing vertical illuminator with collector  
QCPH-IRLEI



Universal rotating stage UT 5  
ICGLI

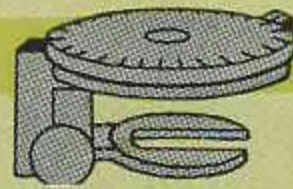

Revolving stage with angle calibration  
No. 237 PEMUP-OZARB

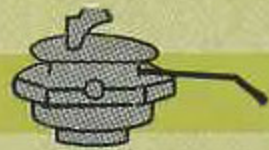

Polarizing condenser  
No. 50 f  
PEVIV

### Microscope tubes

attachable as required and interchangeable by single movement. Advisable for basic outfit: Photo tube FS with inclined binocular eyepieces. Eyepiece height of microscope tubes remains unchanged, since fine focusing acts on object stage.

### Objective carrier

interchangeable, e. g. the revolving objective nosepiece can be changed for an incident light illuminator or other objective carrier.

### Object stages

interchangeable. Basic outfit includes: large mechanical stage with coaxial controls at convenient height. Traversing area 76 x 40 mm; removable specimen holder; stage vertically adjustable independent of coarse and fine focusing.

### Condensers

in dovetail slide horizontally interchangeable and vertically adjustable by rack and pinion.

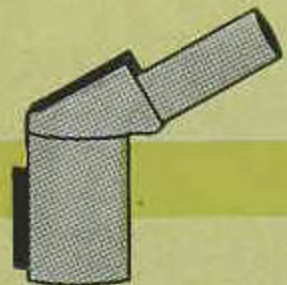

Monocular tube P  
OREEF



Ultropak  
(without objective)  
ORUPO

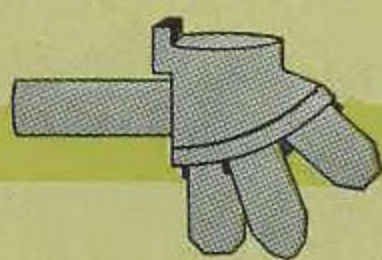

Vertical illuminator with revolving objective nosepiece and 5 objectives IIXVT

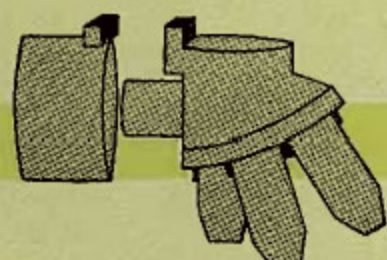

Phase contrast vertical illuminator with revolving objective nosepieces and 5 objectives IIXVT

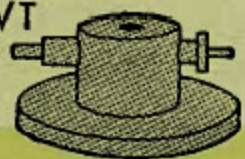

Heating stage "1000"  
HEBII



Micro electronic flash Mikroblitz 300 for transmitted light

## Fields of application

Examinations in transmitted and incident light, or in combined transmitted and incident light with bright field, dark field, and phase contrast illumination, and also in polarized light. Special outfits for metallography and phase contrast microscopy in polarized light, for mineralogy, ore microscopy, and coal petrography, also for measuring reflectivity in incident light with the microscope photometer. Examination of heated specimens. Fluorescence investigations. Microscopic drawing. Bench-top and wall projection. Micro-projection, photomicrography, general survey, and macrophotography.

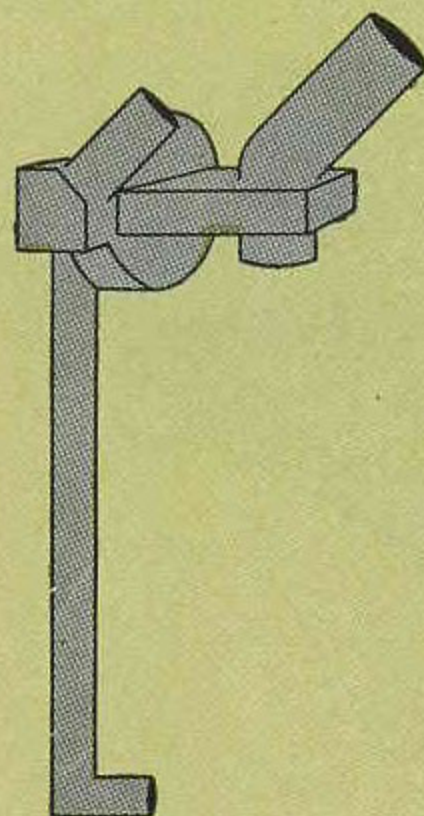

Microscope photometer for incident light  
IIWTQ

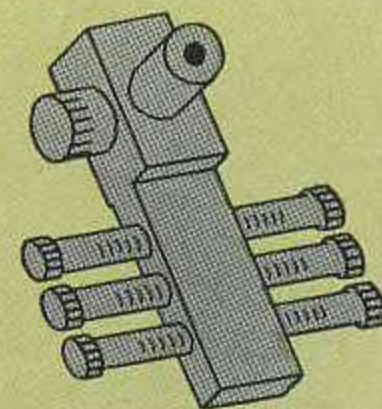

Integrating eyepiece  
INTAF

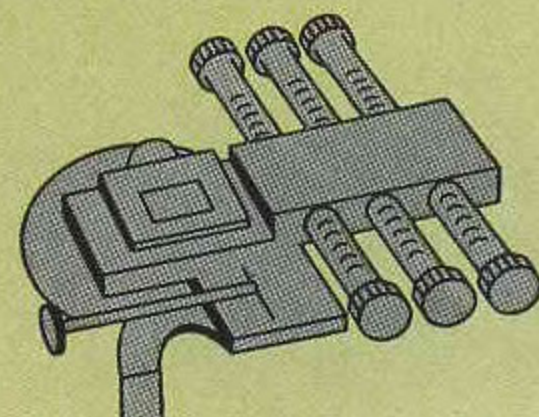

Integrating stage  
OPYUS



## Transmitted Light

The outfit for examinations in transmitted light will in general represent the basic outfit of the instrument.

The Berek two-diaphragm bright-field condenser regulates aperture and field of view with uniform illumination in all ranges of magnification. For other types of illumination, the condenser can be easily exchanged. On turning the revolving objective nosepiece, which is also interchangeable, the objectives are pivoted to the rear, and do not obstruct the full view of the object stage. A notable feature is the spring mounting of objectives of medium and high magnifications. It responds even to light contact with the specimen, and thus forms an effective specimen protection.

## Plano Objectives

To meet high requirements in respect of the size of the field of view and flatness of field, the use of plano objectives is to be recommended. In combination with wide-field eyepieces, as compared with the usual objective-eyepiece combinations, the field of view obtained is up to more than twice as large and shows excellent elimination of image curvature.

The correction of the plano objectives (the highest power of which is of the Apochromatic type) has been adjusted one to the other in such a manner that they are all equally suitable for colour photography.

A special feature is the large working distance, which amounts to 0.27 mm for example for oil immersion. The plano objectives including the oil immersions are arranged parfocally on the revolving objective nosepiece.

**Outfit: ORTHOLUX with lamp attachment for transmitted light, photo tube FS, quadruple revolving objective nosepiece, mechanical stage No. 50, two-diaphragm bright-field condenser No. 76, case for the accessories, ready for connecting up to 220 volts A. C., with optical equipment A 2 a for magnification from 26 to 1250 x** OLTEX-REDYX

**Optical equipment A 10 with plano objectives and pair of wide-field eyepieces, for magnifications from 50 to 1250 x, including quadruple revolving objective nosepiece on carrier** ..... OPGIX-ORKAT

ORTHOLUX research microscope equipped with mechanical stage No. 50, binocular tube S, plano objectives and wide-field eyepieces, and two-diaphragm bright-field condenser No. 76 for examinations in transmitted light.

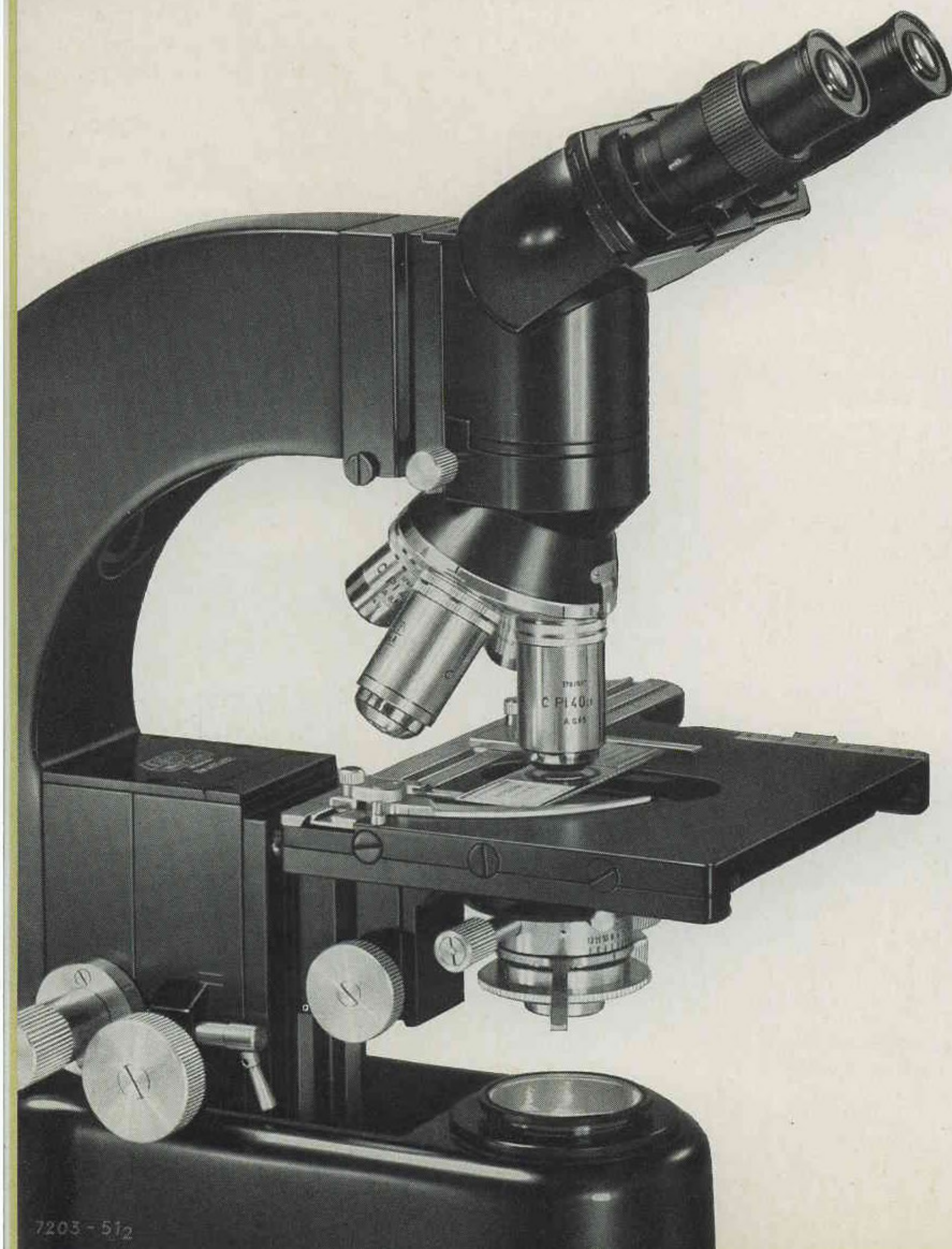

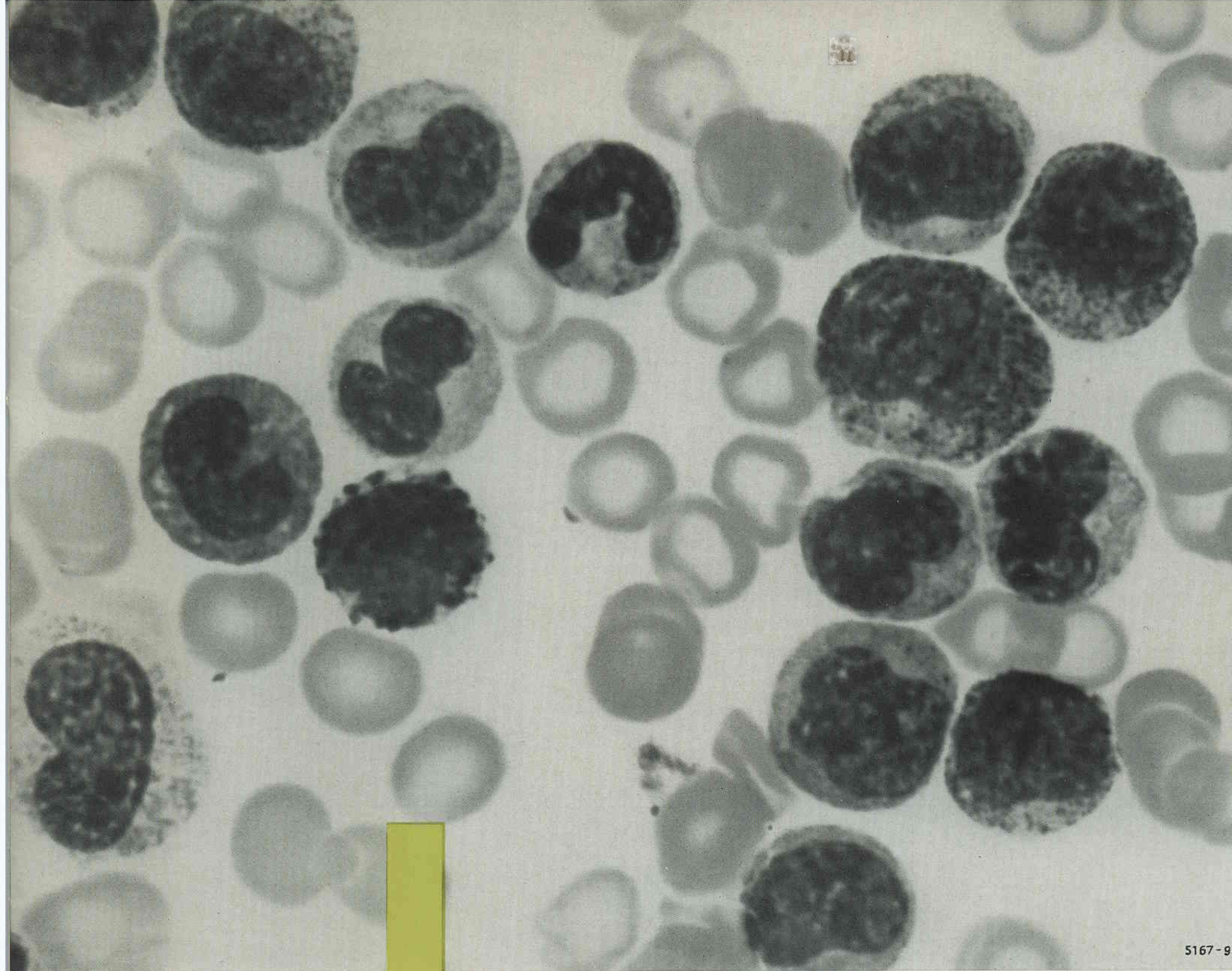

5167-9

Human bone-marrow smear

Taken with the plano objective PI Apo Oil 100/1.32; periplanatic eyepiece 6x;  
Ortholux with photomicrographic apparatus Aristophot,  
mirror reflex attachment, plate size 9 x 12 cm (3 1/4" x 4 1/4");  
image scale on the negative 1000:1, subsequently enlarged to 2500:1.

"Sandkühler's counting eyepiece" has been designed as a special  
eyepiece for the counting of bone marrow smears.



## Phase Contrast Illumination

Observations in phase contrast can be carried out with the ORTHOLUX in a very simple manner. The LEITZ phase contrast equipment offers the added advantage that besides the clearly defined phase contrast of Zernike, it also allows setting bright field and dark field illumination in continuous sequence. The change from bright field to phase contrast and vice versa is gradual. The required type of illumination is obtained through the vertical adjustment of the mirror body of the phase contrast attachment; the specimen remains fully visible without interruption during this process. Moreover, in combination with polarizing filters it is also possible to carry out general survey observations in polarized light in order to observe double refraction, also in combination with phase contrast. For **positive phase contrast**, the phase contrast objectives are supplied with normal or high absorption, while objectives for **negative phase contrast** are supplied with high absorption.

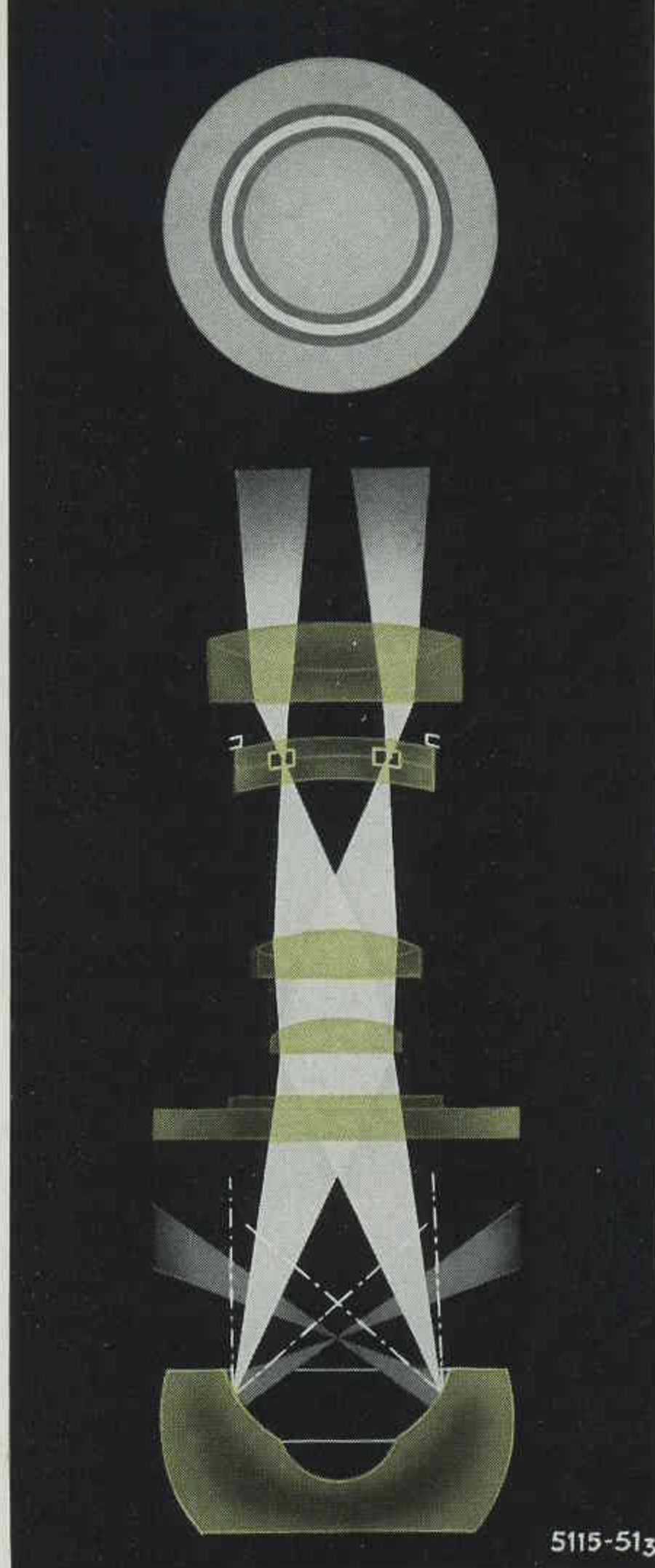

The illustration shows the beam path with phase contrast illumination.

Outfit with LEITZ phase contrast equipment for examination in transmitted light. The photo tube FS with binocular inclined eyepieces is shown without the vertical eyepiece tube for photomicrography.

LEITZ phase contrast equipment consisting of Heine condenser and optical equipment C 3 for histology; quadruple revolving objective nosepiece on bracket; magnifications 100 to 1050 x ..... PFAHT-FOAMC-ORKAT

Detailed information is given in the catalogue "LEITZ Phase Contrast Equipment" [513-5 a/Engl.]



Germinating spores of *Penicillium glaucum*. Objective Pv Fl Oil 70/1.15 n; positive phase contrast. Panphot; plate photograph 9x12 cm; scale 750:1.

Culture three days old. In positive phase contrast, the drops appear dark, the vacuoles as bright cavities, the intervening walls as dark membranes, and the remaining cell inclusions also appear dark.

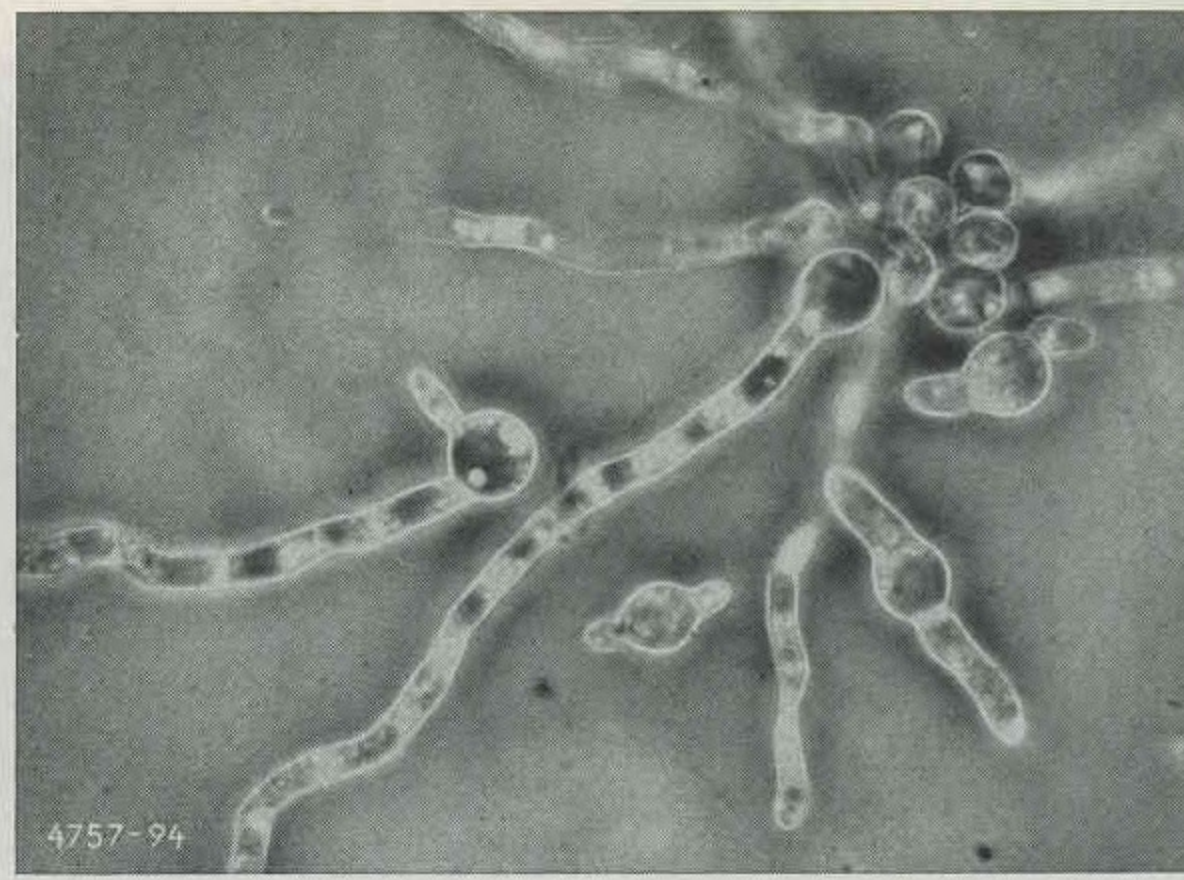
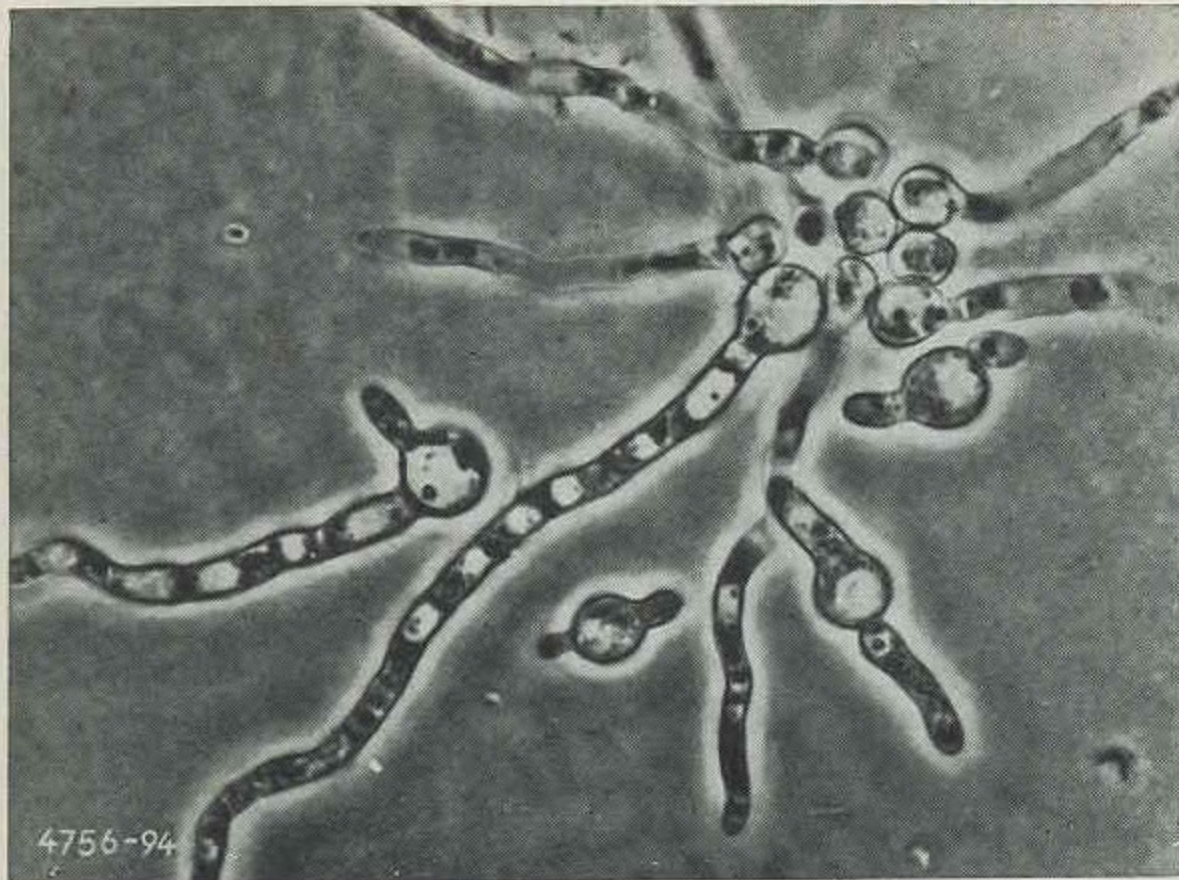

Picture on right; preparation as above, but objective Pv Fl Oil 70/1.15-h. (negative phase contrast). In negative phase contrast conditions are reversed. Which the polarizing attachment for the phase contrast condenser, double refractive cell elements can be easily distinguished from the remaining cell components.

Rat kidney, phase contrast. Unstained section. Objective Pv Fl Oil 70/1.15 n; Plate photograph 9x12 cm; scale 1100:1.

In phase contrast, kidney particles, cell nuclei, cell membrane and nucleoles are seen with particular clarity. The Bowman's capsule, the membrana propria and the glomerulus loops can be recognized in all their details.

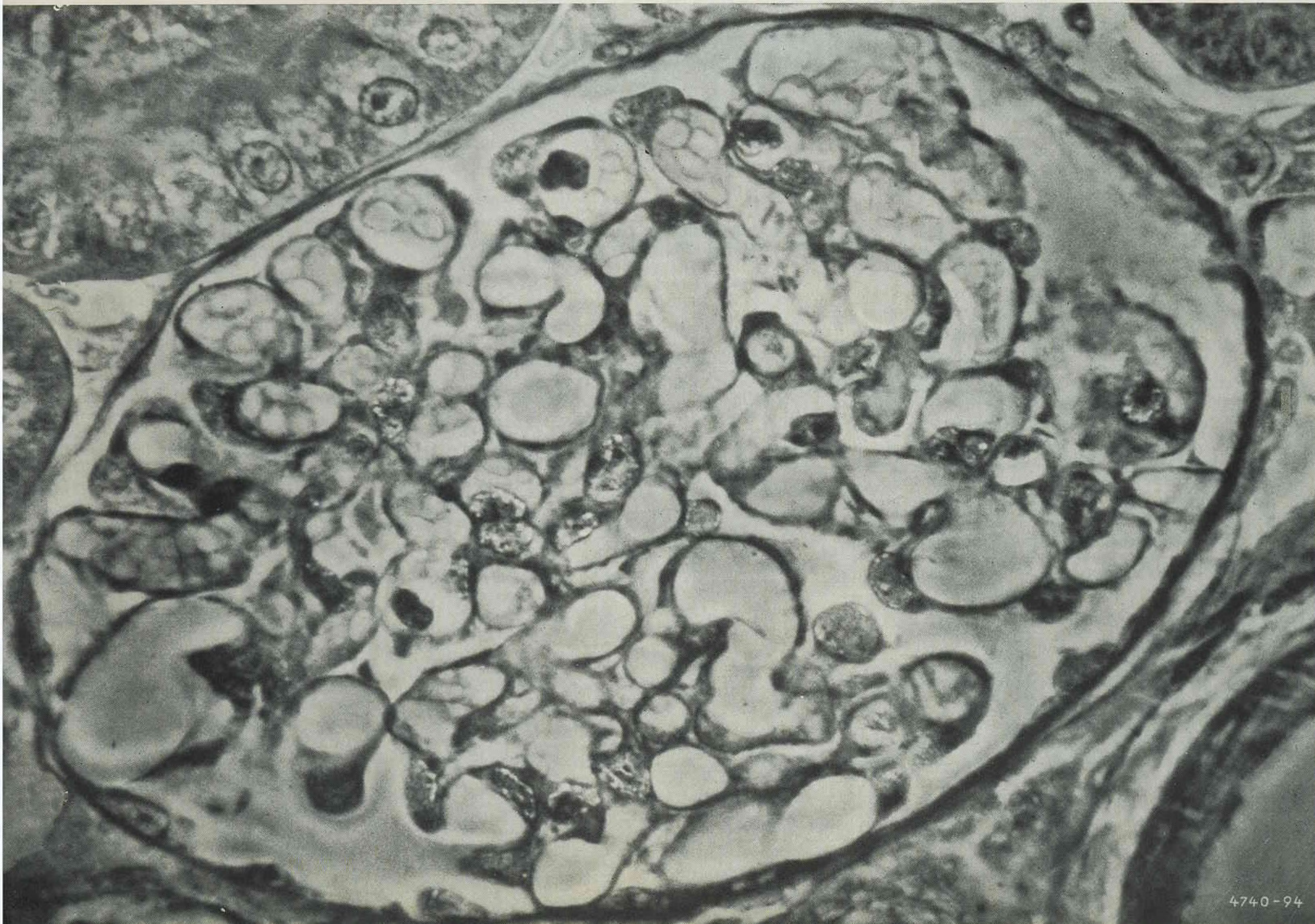

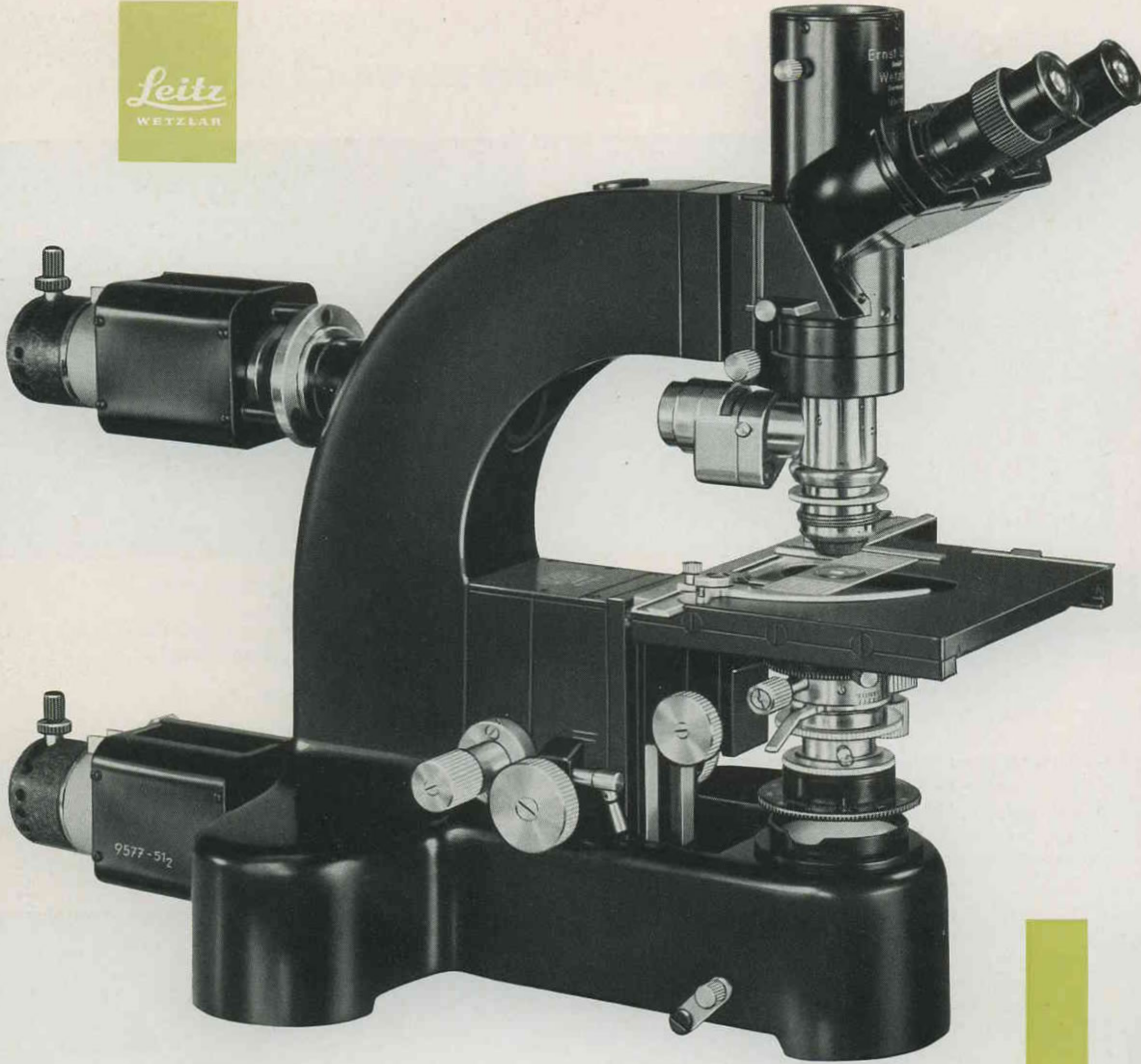

Outfit for examinations in combined transmitted light and incident light, with 2 lamp attachments (6 volts, 30 watts), photo tube FS with inclined binocular body (without photo tube), ULTROPAK incident light illuminator, Berek two-diaphragm bright-field condenser, and VARIOCOLOR attachment in position.



6529-51<sub>3</sub>

**VARIOCOLOR**  
attachment .... LUXOW-LUYAT

## Incident Light with the ULTROPAK<sup>®</sup>

If a laboratory has to carry out examinations in incident light, then the ORTHOLUX offers special advantages. After exchanging the revolving objective nosepiece for the ULTROPAK incident light illuminator, the instrument is immediately ready for use, since the illuminating beam always remains centred for observations in incident light also. (For details on the ordinary vertical illuminator see page 12.) The main field of application of the ULTROPAK is the observation of natural surfaces such as those occurring in botany, zoology, parasitology, and experimental medicine, as also in the examination of surface structures in industry.

### Supplementary items to the outfit on page 6

ULTROPAK incident light illuminator on bracket .....	ORULTSINE
Optical equipment H 1 for general technological examinations, magnifications from 30 to 138 x .....	BEEMG
Lamp attachment (6 volts, 30 watts) for the upper section of stand .....	OLTUB
Regulating transformer for connecting up this lamp .....	REDYX

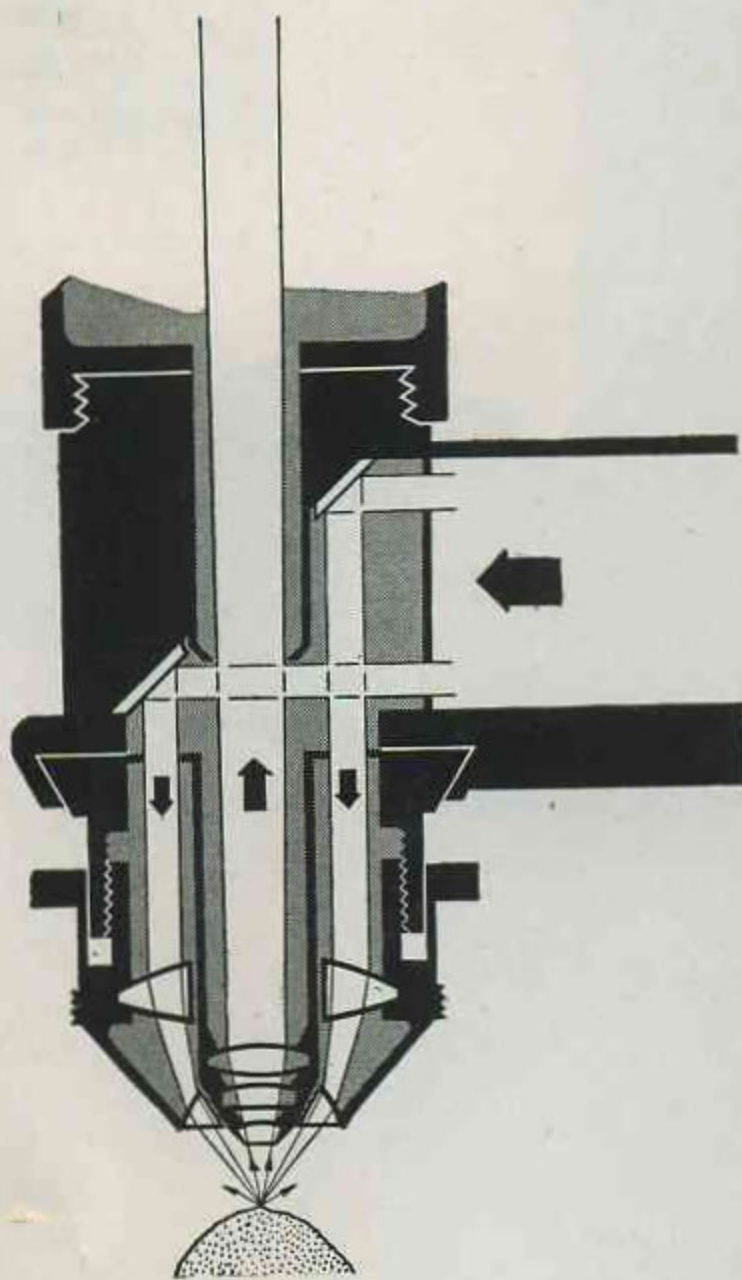

The above diagram shows the beam path in the ULTROPAK incident light illuminator. The illuminating attachment guides the light concentrically to the specimen by way of an annular mirror and a vertically adjustable ring condenser. The most favourable vertical adjustment of the condenser depends on the nature of the specimen. For the ULTROPAK there are dry and oil immersion objectives with an initial magnification of 3.8 to 100x with the corresponding immersion caps and dipping cones for observations on moist materials or in liquids. In such cases it is advisable to use the supplementary polarizing equipment in order to eliminate surface reflections.

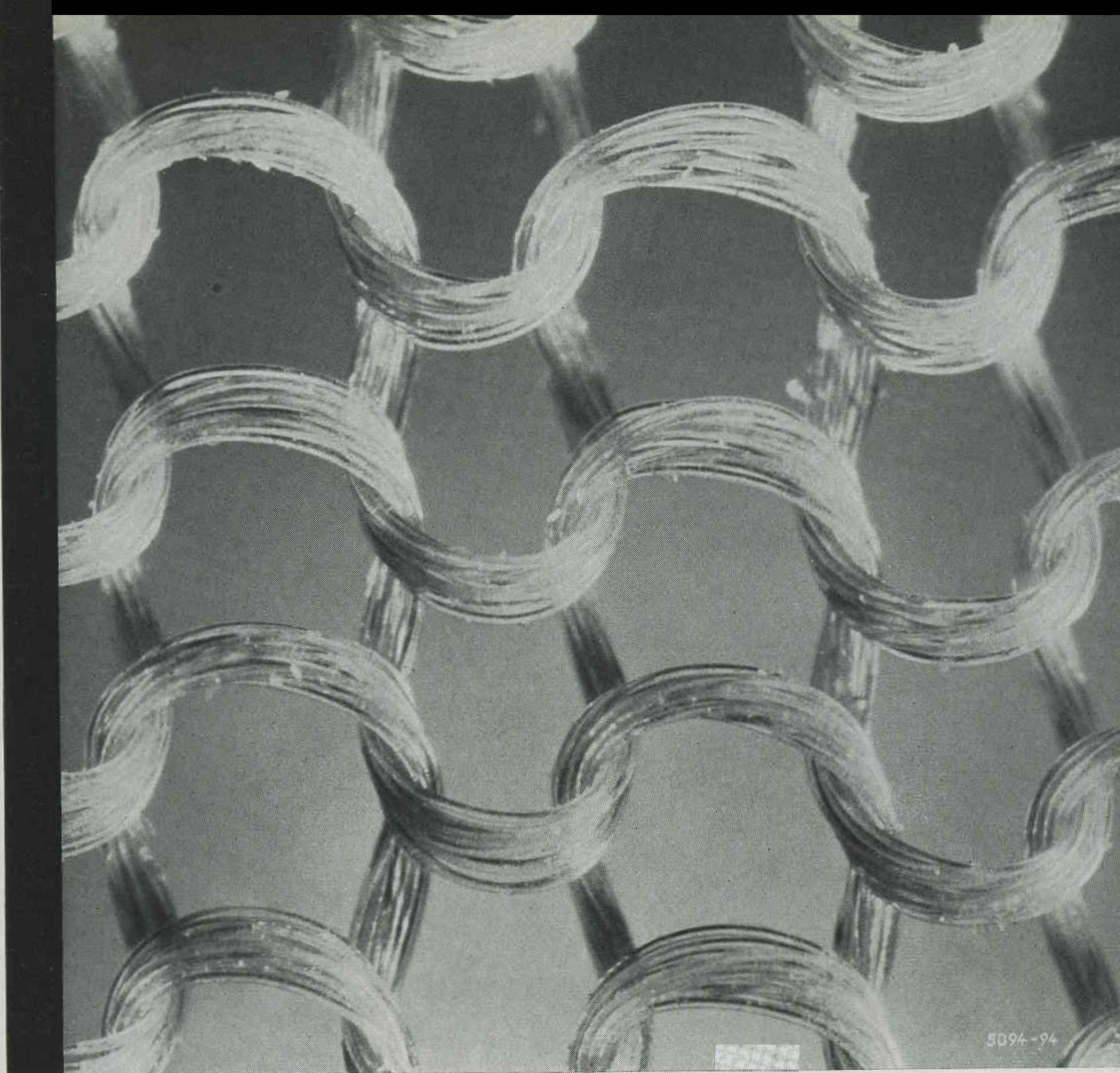

Nylon fabric, reinforced.

By combining incident illumination – which shows up the relief of a transparent specimen clearly with the aid of sector diaphragms – with a background illumination contrasting with the colour of the specimen, an impressive presentation of the fine textile structure is obtained. It can still be recognized in black and white.

Ultropak objective 5x/0.15, eyepiece 6x, Variocolor; scale on the original negative 9 x 12 cm 40:1, subsequently enlarged to 60:1.

## Combined Transmitted and Incident Light

This method offers valuable advantages with certain specimens. Owing to the separately arranged sources of light, it can be readily carried out using the ULTROPAK and the two-diaphragm bright-field condenser. By also attaching the VARIOCOLOR®, the transmitted light can be varied continuously in the range of all colours of the rainbow and beyond to purple. Specimen details with characteristic colouring of their own thus appear particularly clearly in colour contrast against the surrounding field.

A detailed account of the Ore Dressing Microscope equipped in this manner is given in catalogue [52-1/Engl.](#)

METALLUX metallographic microscope  
with lamp attachment  
(6 volts, 30 watts); photo tube FS; vertical  
illuminator fitted with revolving nosepiece and  
5 objectives for standard magnifications  
from 50 to 1000x;  
large mechanical stage No. 250.

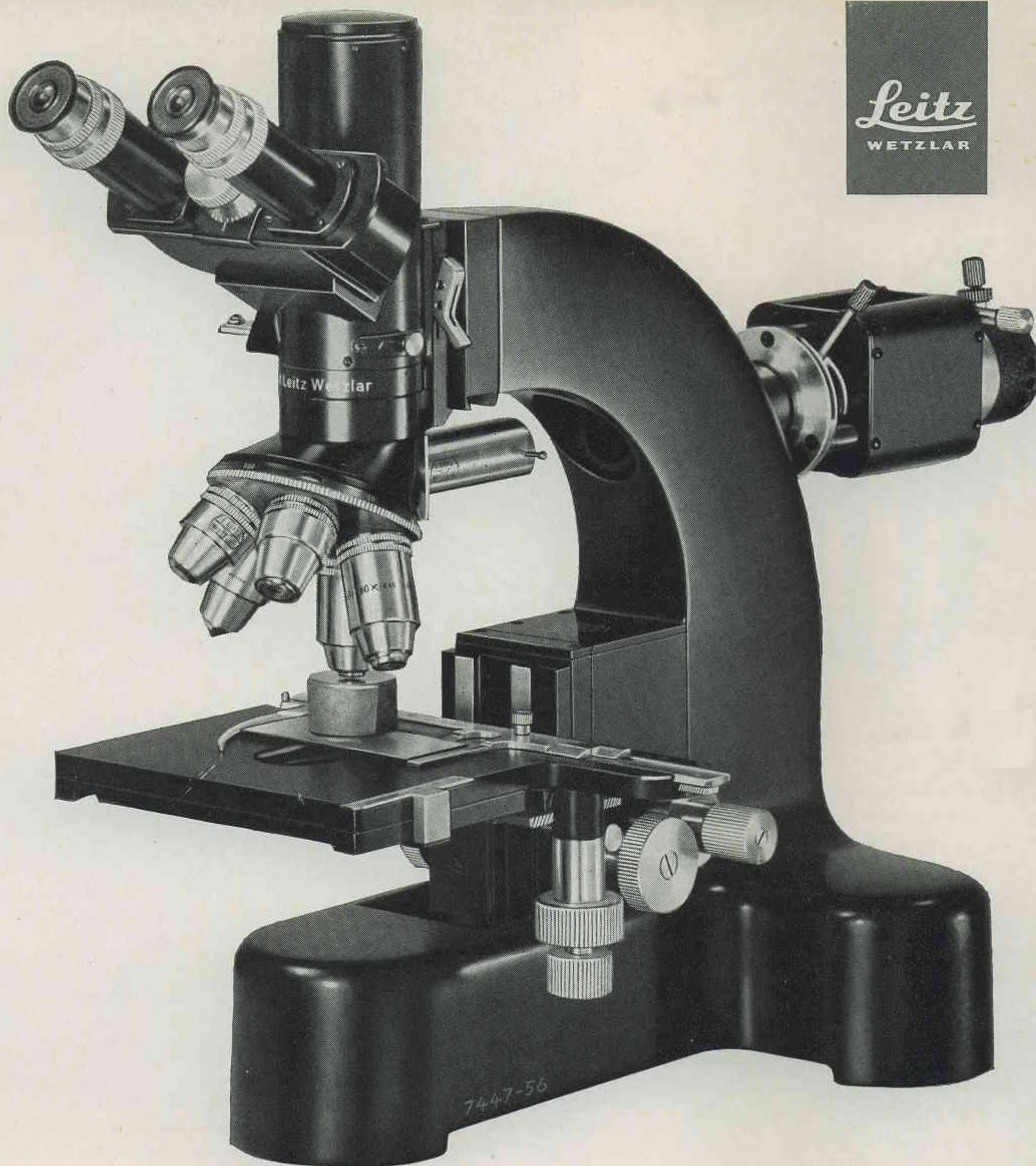

## Metallographic Examinations

The ORTHOLUX universal microscope can readily be adapted for the requirements of metallography. But if such examinations represent the main field of activity, then it is advisable to use the special design METALLUX®. This incident light microscope corresponds to the ORTHOLUX to a large extent in its construction, but it is designed exclusively for metallographic work. In combination with a 10x eyepiece, the vertical illuminator with revolving nosepiece for five objectives gives the standard magnifications of 50, 100, 200, 500, and 1,000x. The binocular tube of the METALLUX permits selection of the most favourable image section in the field of view and direct focusing of the image in the eyepiece, when taking photomicrographs with the camera attachment developed for the METALLUX.

® = Registered Trade Mark

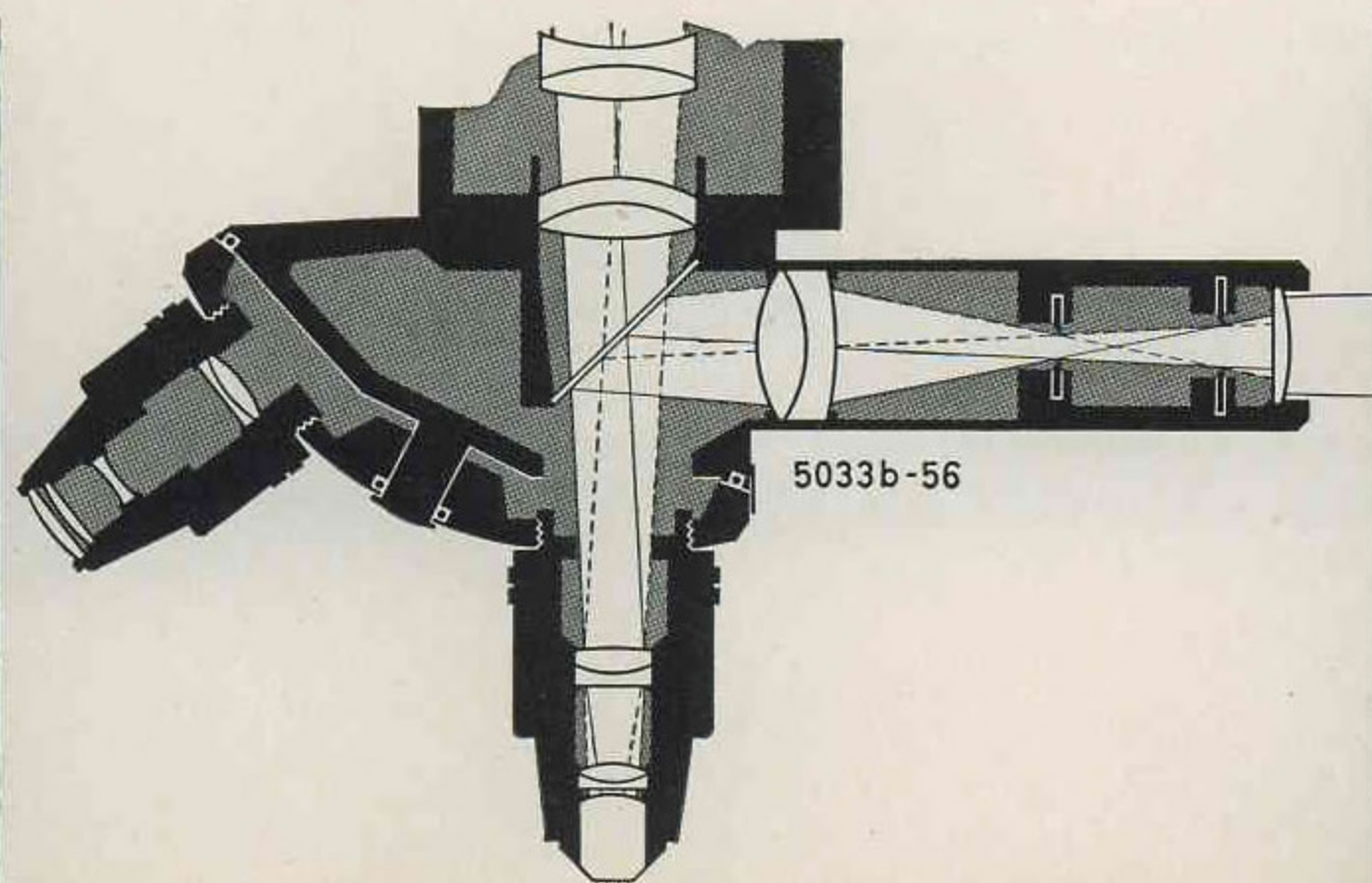
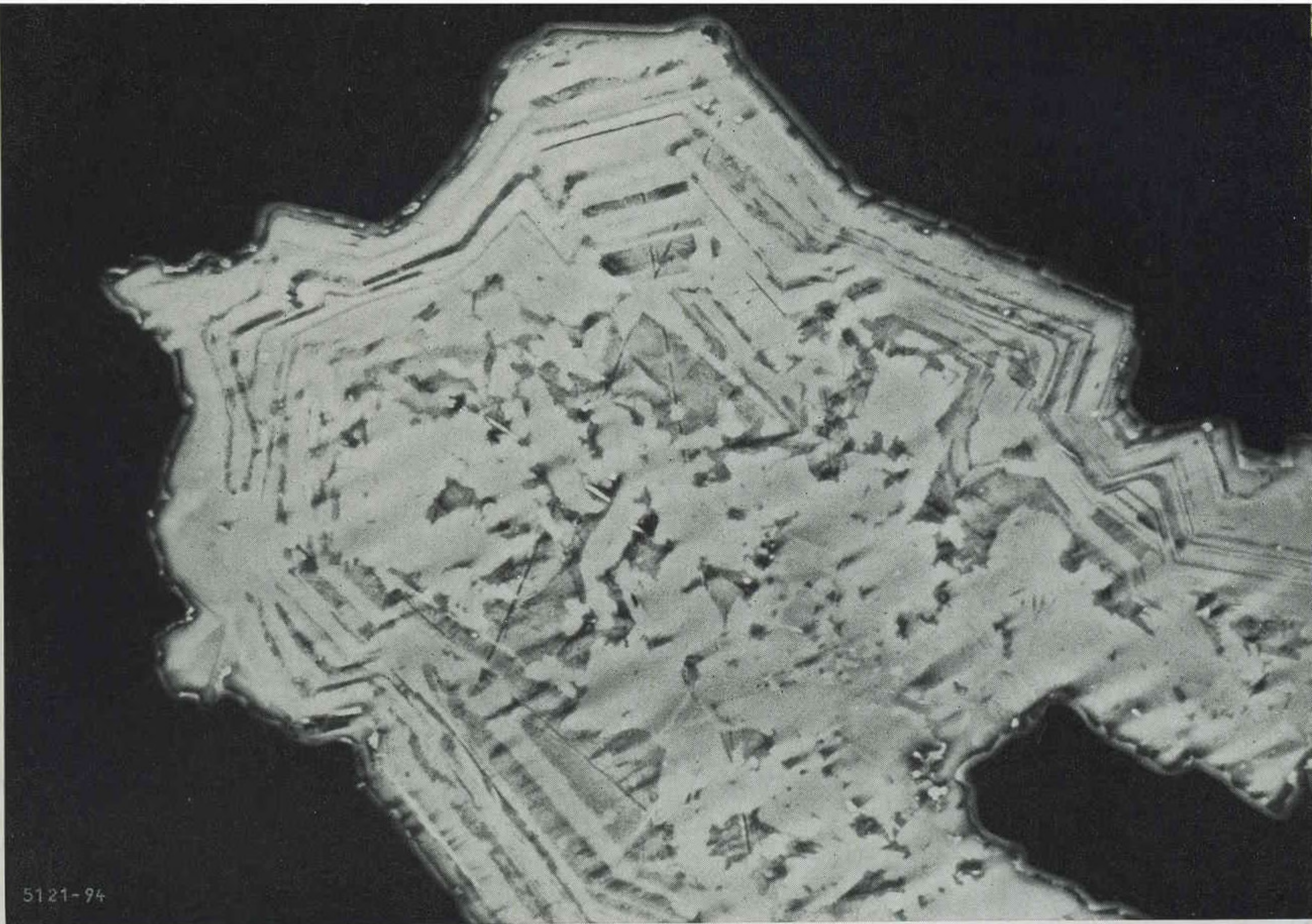

Diagram of the vertical illuminator  
with revolving nosepiece  
for 5 objectives.

Unetched ore specimen (bismuth, safflorite, smaltite) embedded in synthetic resin; LEICA photograph with objective Pv 20x standard magnification 200x (with 6.5x9 cm) phase contrast illumination.



## Phase Contrast Illumination by Incident Light

For incident light observations with phase contrast illumination, the METALLUX is available in a special design. It permits direct comparison of the phase contrast image with the bright-field image and thus supplies the essential information on the microstructure of a surface in rapid change – and yet independent of each other. Observation in bright-field shows the differences in the reflection capacity of the structure detail, while the phase contrast illumination shows for example the minutest differences in height or refraction of the specimen as differences in brilliance.



The same ore specimen as above, with bright-field observation.

Detailed description of METALLUX in catalogue [56-3/Engl.](#), and of Phase Contrast-METALLUX in catalogue [56-9/Engl.](#) Supplementary equipment for ORTHOLUX will be quoted for on request.



Large polarizing microscope ORTHOLUX-POL with binocular polarizing tube, equipped for examinations and measurements in transmitted light.

## Examination and Measurements in Polarized Light

The ORTHOLUX research microscope also offers facilities through equipment with suitable attachments for polarization-optical examinations and measurements in transmitted and incident light such as occur in mineralogy, ore microscopy, coal petrography and material dressing technology. But for extensive work in this field, it is advisable to select a special polarization-optical outfit, so that it is always ready for immediate use. A new development for such a special equipment is to be seen in the **polarizing body for binocular observation** and photomicrography. With this it is possible to carry out not only orthoscopic but for the first time also conoscopic observation and measurements binocularly. The microscope fully equipped for work in polarized light is supplied under the designation ORTHOLUX-POL.

Thin polished rock specimen. The various crystals which make up the rock can be determined by their mostly colourful appearance in polarized light.

The present picture shows a diallage-like, massive rock made up primarily of feldspars.

They can be seen here in lamellar inter-crescence and in crystals traversed with numerous fissures.

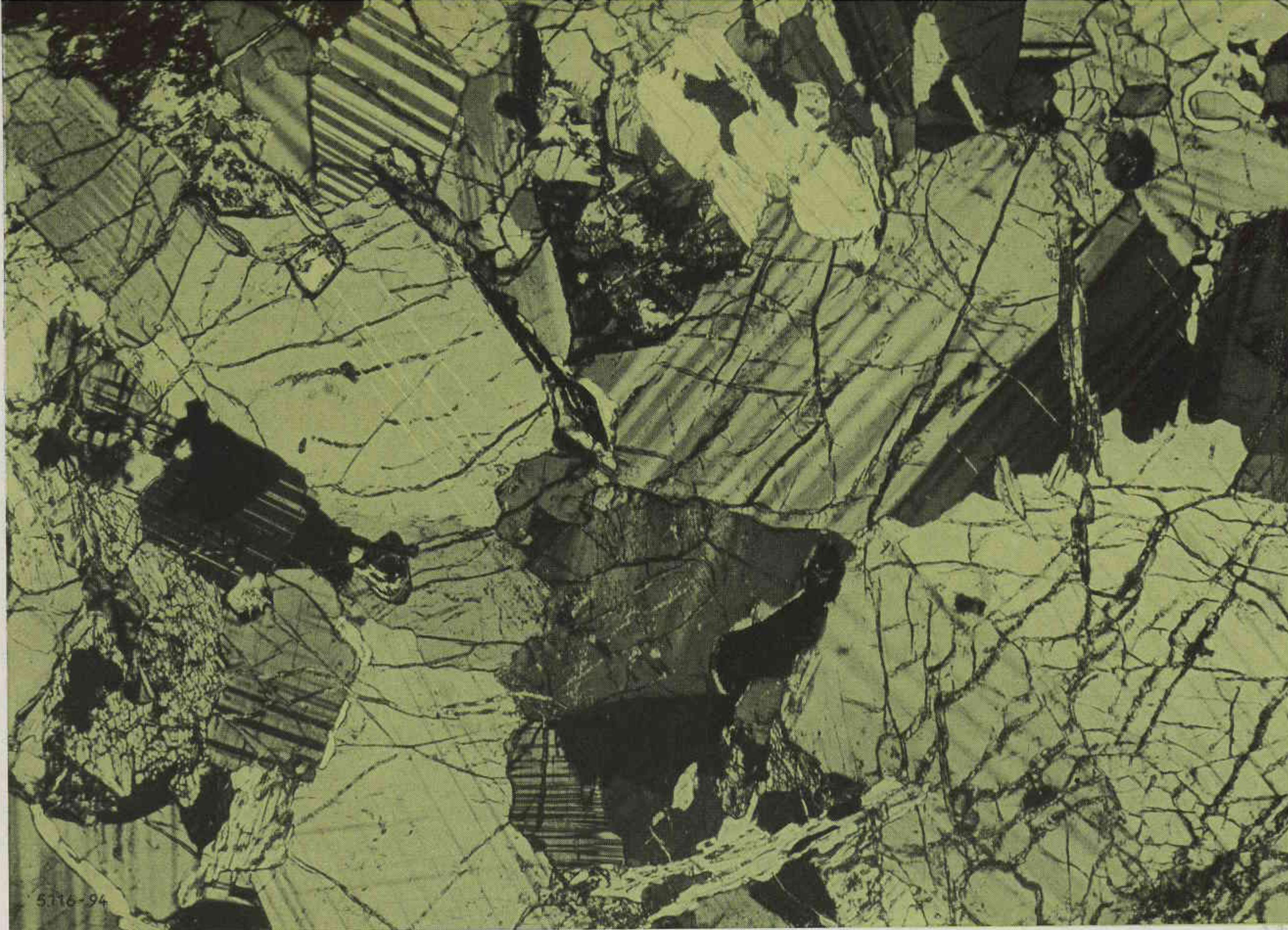

## Examinations in Incident Polarized Light

For polarization-optical observations and measurements in incident light on mineral objects, in particular in the examination of ores and coals, a **polarizing vertical illuminator with front collector and diaphragm slide** can be attached. Plane glass or prism can be moved into the beam path as required.

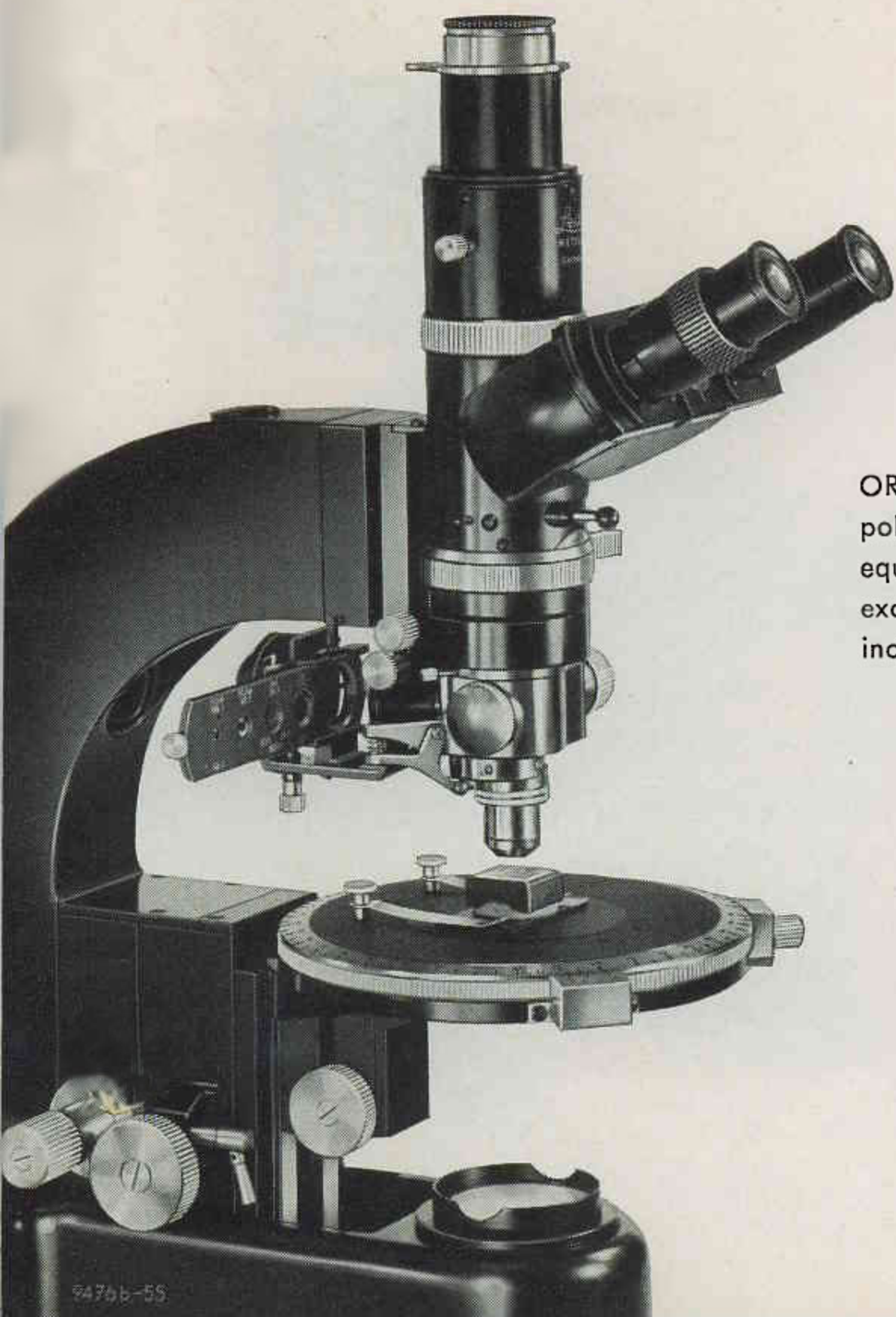

ORTHOLUX-POL polarizing microscope equipped for examinations in incident polarized light.

## Examinations in Transmitted and Incident Polarized Light

Some examination problems may require an outfit for polarized transmitted and incident light. This is readily possible. For this purpose the vertical illuminator and the polarizing condenser for transmitted light are used simultaneously. But special examinations and measurements in transmitted light are best carried out with the objective centring clutch or centring revolving nosepiece and the corresponding non-polarizing transmitted light objectives.

Details on supplementary equipment for the ORTHOLUX will be gladly supplied on request.

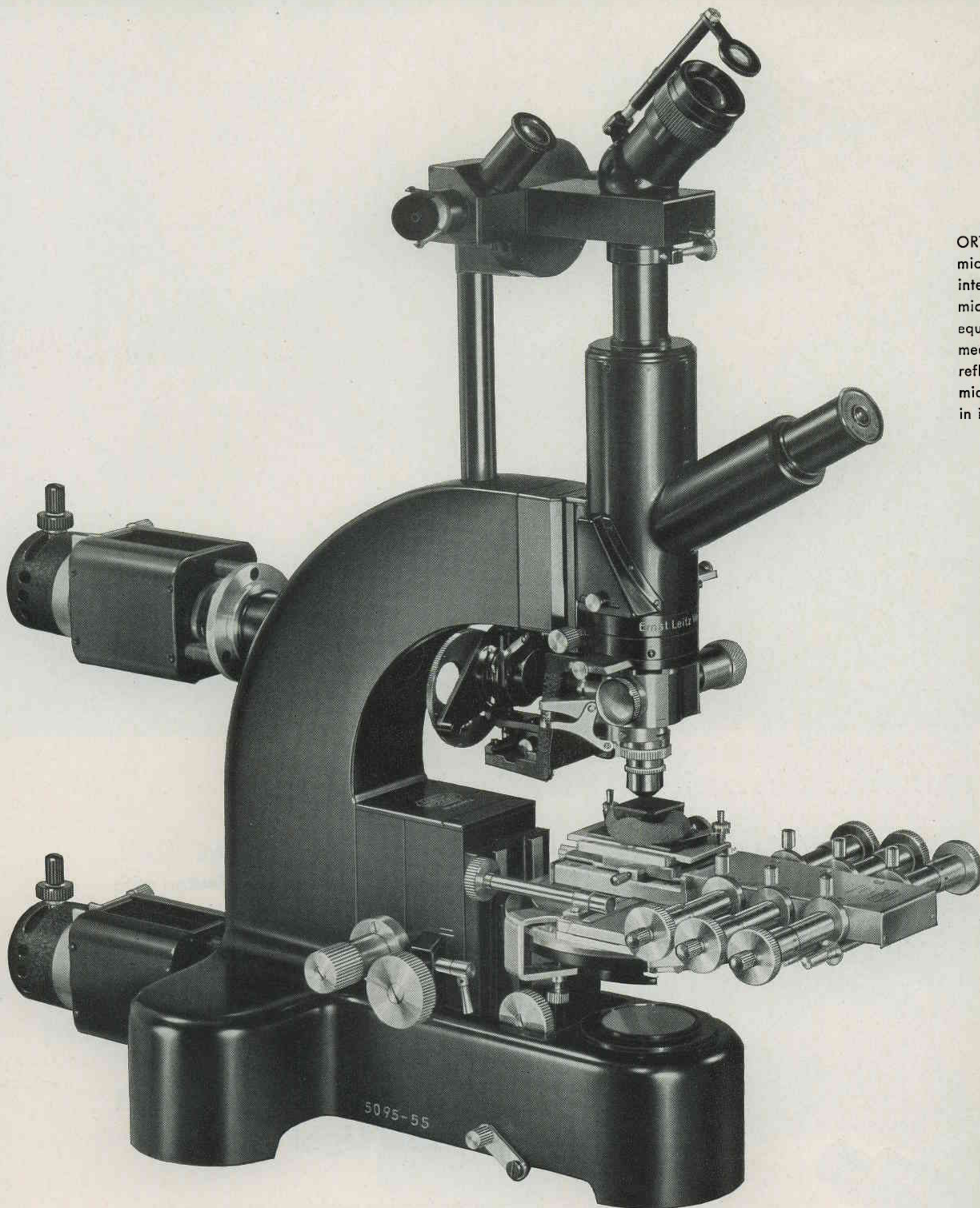

ORTHOLUX  
microscope with  
integrating stage and  
microscope photometer,  
equipped for the  
measurement of  
reflectivity and  
microscopic examinations  
in incident light



## **ORTHOLUX with Microscope Photometer and Integrating Stage**

For the **measurement of reflectivity in incident light**, particularly in coal-petrographical examinations, the microscope photometer can be combined with the ORTHOLUX. Microscopic examinations and reflection measurements can then be carried out successively by means of a change-over device. The **integrating stage** is used for carrying out precise planimetric analyses. It is designed with six independent measuring spindles with which the various components of a specimen can be measured out in an area of 18x18 mm.



## Sources of Light for Special Purposes

Certain microscopic examinations demand the use of special lamps. Here also the ORTHOLUX offers a versatile range of adaptations and applications as a result of its ingenious design. Other sources of light can be readily attached in place of the low-voltage lamps. The LEITZ fluorescence lamp and the xenon lamp are both designed with lateral connections to fit the low-voltage lamps belonging to the microscope, so that by simply pivoting a mirror, these sources of light may also be used as required. The **fluorescence lamp** with the Philips CS 150 watt mercury high-pressure lamp for examinations with ultraviolet or blue light fluorescence is available in two designs, i. e. for examinations in transmitted light and as a twin lamp for examinations in incident or combined transmitted and incident light (see ill. below.). This mercury high-pressure lamp has proved particularly suitable owing to its high radiation density in the blue spectral range (436 and 404 m $\mu$ ) and in short-range (ultraviolet (366 m $\mu$ )). As a source of light of high light density for the visible spectral range, we recommend the **LEITZ Xenon lamp** with the Osram XBO 162 xenon high-pressure lamp. This lamp is suitable for photomicrography and cinemicrography in transmitted and incident light bright field, and for transmitted light phase contrast and also polarized light. Owing to its continuous spectrum which resembles sunlight, it permits colour-true reproduction on daylight colour film. The Xenon lamp can also be used for blue-light fluorescence.

- Fluorescence lamp for examinations in transmitted light, ready for connection to 220 volts A. C., with microscope support ..... LUPAK  
 Fluorescence twin lamp for examinations in transmitted and incident light, ready for connection to 220 volts A. C.  
 with microscope support ..... LUORT  
 Xenon lamp, ready for connection to 220 volts A. C., with microscope support ..... LAZAZ  
 (Electrical equipment for other supply voltages is quoted for on request)

LEITZ  
 fluorescence twin lamp on  
 the ORTHOLUX

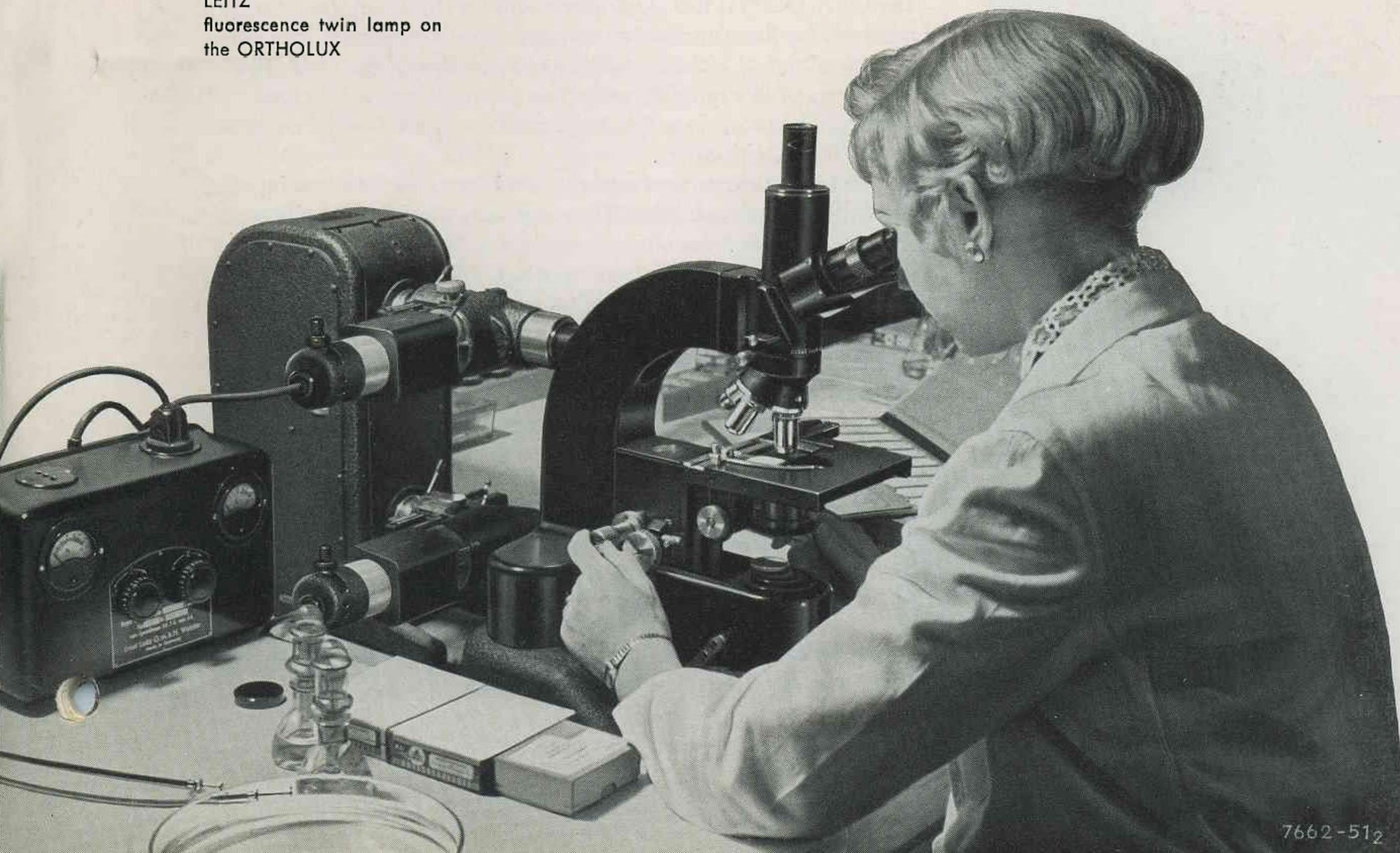

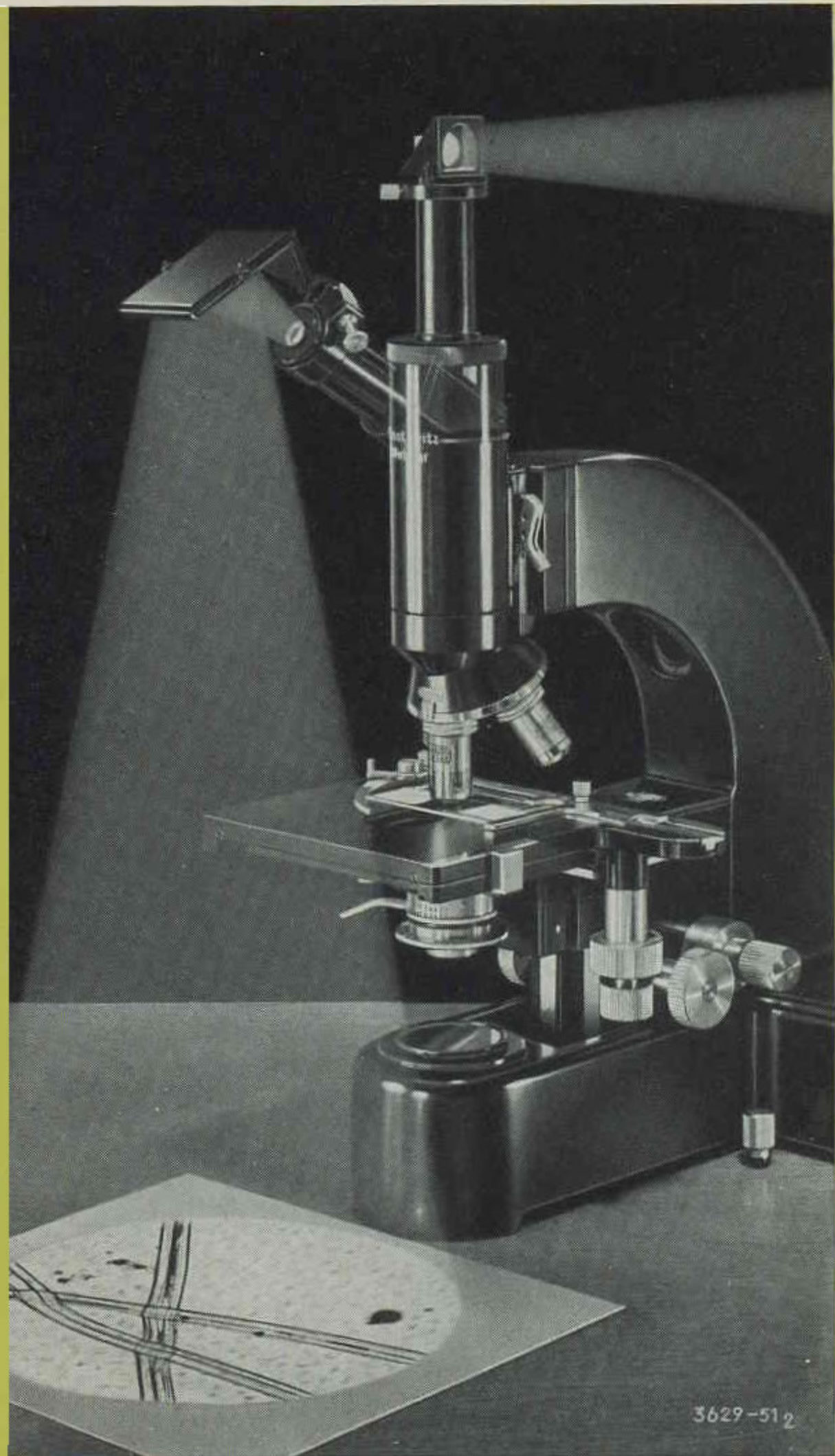

Wall and bench projection with the ORTHOLUX (above)  
 Heating and cooling stage "350" on the ORTHOLUX (below).  
 For the sake of clarity, the connections for heating and  
 cooling have been omitted in this illustration.

## Supplementary Microscopic Equipment

Such equipment can be readily attached to the ORTHOLUX without exception. Thus for general polarization-optical work in biology and in industrial processes, high-grade attachable polarizing filters are available.

With Schmidt's polarizing equipment, it is also possible to carry out analytical work. This equipment consists of a polarizer which can be moved into and out of operation, and is attached to the two-diaphragm condenser in combination with a swing-out  $1/16\lambda$  mica plate, and a rotating analyser to fit onto the straight connection of the photo tube. Gypsum and mica plates can be inserted in orientated position.

Attachable revolving stage ..... ORDRESINE  
 Attachable polarizer and analyser filters ..... ORPOL-ORNAL  
 Schmidt's polarizing device, in case ..... POSES

By wall projection, the microscopic image can be made accessible to a small audience simultaneously. All that is required is a prism to fit onto the vertical tube. Bright screen images with a diameter of up to about 3 feet are obtainable.

Adjustable projecting prism ..... PRIAU

In order to trace the image on the bench surface in front of the microscope, a mirror can be attached to the inclined eyepiece of the microscope tube.

Drawing mirror, pivoting (for use with tubes FP and P) ..... PIIGL

It may be assumed that readers are familiar with the use of general accessories such as micrometer eyepieces, stage micrometers, demonstration eyepieces, etc. They are all used on the ORTHOLUX in the usual manner.

## Heating and Cooling Stages\*

The ORTHOLUX is the ideal instrument for applying the heating stage methods for the examination of organic and inorganic specimens in transmitted or incident ordinary or polarized light. Even the objectives of low magnification can be used here with a long working distance, since the stage can be adjusted on its carrier to a very low position.

To meet the various requirements, a selection of four heating and cooling stages is available. They comprise model "80" with automatic thermo-regulation for vital examinations\*\*), model "350" as a melting point apparatus, heating stage "1000", and the vacuum heating stage "1050" for metallographic work. With the last two stages the use of special heating stage objectives is recommended. In this combination they permit observation with apertures of up to 0.60 and magnifications of up to about 600x.

Heating and cooling stage "80" with automatic thermo-regulation, for temperatures from  $-20^{\circ}$  to  $+80^{\circ}$  C, ready for connection ..... HECOG

Centring stage base No. 33 with interchange bracket for heating and cooling stage "80" ..... IDYAP

Heating and cooling stage "350" for temperatures from  $-20^{\circ}$  to  $+350^{\circ}$  C, ready for connection ..... HEBOF

Normal objectives up to aperture 0.25 and total magnifications of up to about 250x can be used with all heating stages. Special objectives with higher apertures will be quoted for on request.

\*) The designations of the heating stage indicate the upper temperature limit.

\*\*) All condensers and objectives can be used here.

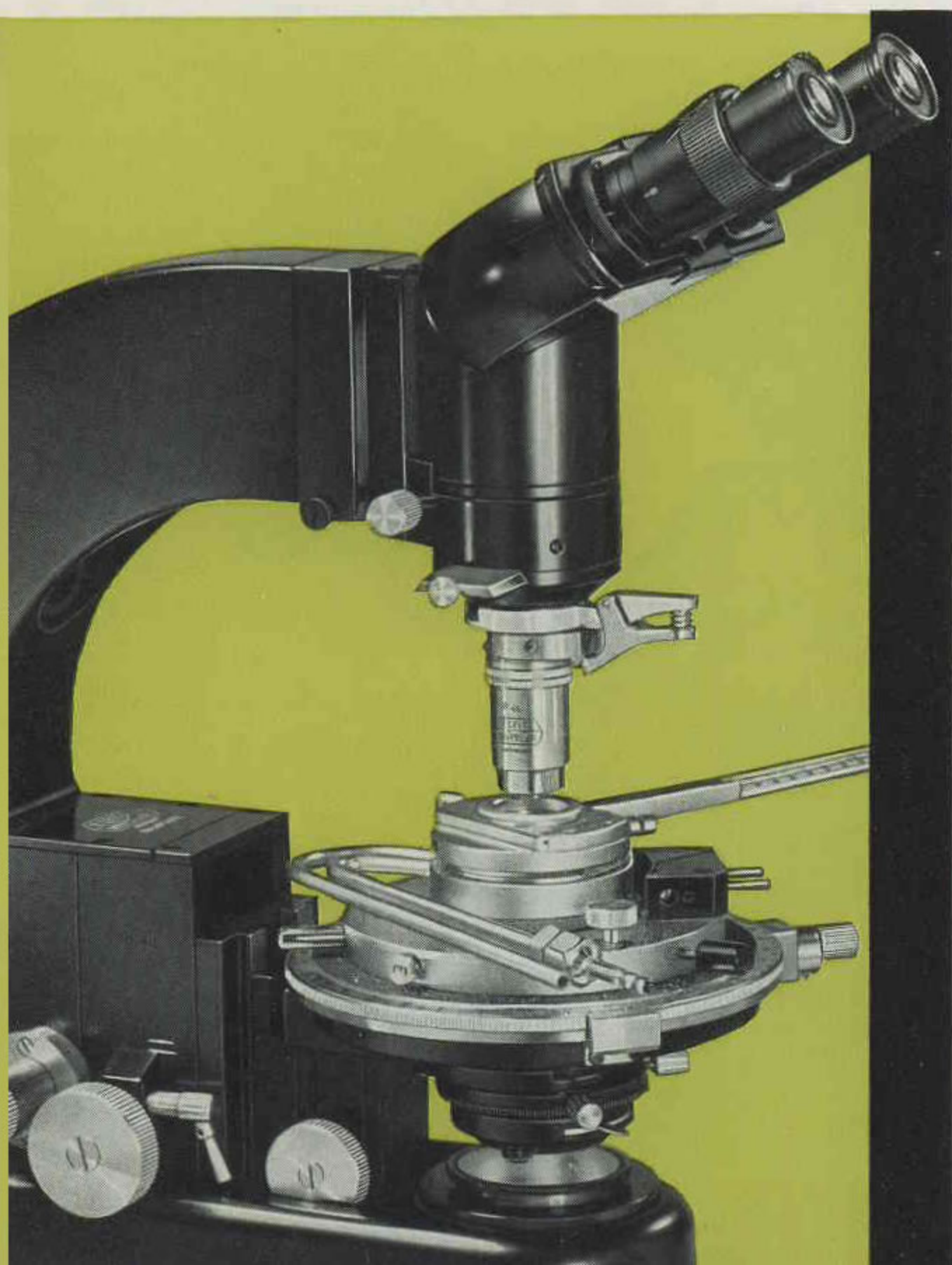

## Camera Attachments

Photomicrography is possible by the simplest means with a 9x12 cm camera attachment, with the MIKAS micro attachment and a LEICA body. Both attachments are inserted into the vertical tube in place of the eyepiece; they are equipped with a time and instantaneous shutter and with flash synchronization.

MIKAS micro attachment with  $\frac{1}{3}x$  intermediate adapter for use with a LEICA 35 mm camera ..... **MIKAS**  
 Camera attachment for plates 9x12 cm ( $3\frac{1}{4}'' \times 4\frac{1}{4}''$ ) ..... **MAKAM**  
 Double release for shutter and observation prism of the focusing telescope, for both attachments ..... **CALOS**

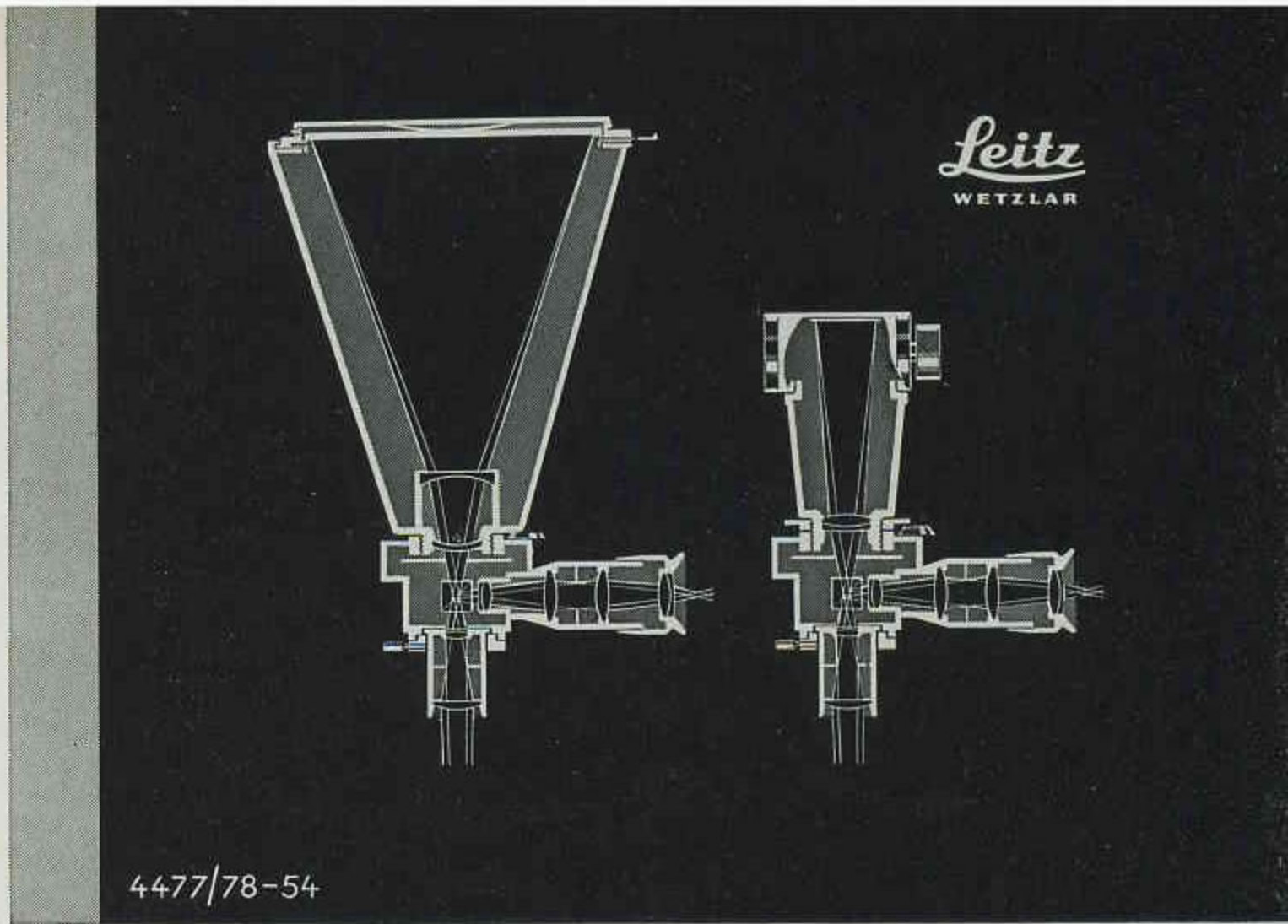

## Exposure Meter

For the determination of the correct exposure in black and white and colour photomicrography, the exposure meter MICROSIX® has proved very effective owing to its wide measuring range. The measuring eye (selenium photo-electric cell) is connected to the measuring instrument by a cable, and can be used at any appropriate measuring point of the microscope, or at the observation ground glass screen of the mirror reflex attachment.

Exposure meter ..... **MITIX**



## Electronic Flash Equipment

Photographs with the electronic flash are of particular importance for the photography of living microscopic specimens. They can be taken easily with the ORTHOLUX, if the electronic flash attachment Mikroblitz 300 is used. It is designed with a flat flash tube which gives completely uniform illumination over an area 9 mm in diameter on discharge. The flash tube does not disturb the beam path of the built-in illumination, and the specimen can thus be observed unhindered until the shutter release is pressed. The brilliance of the flash illumination can be varied according to the specimen and the magnification used. The electronic flash is designed for use with transmitted light.

Mikroblitz 300  
 micro electronic flash equipment  
 ready for connection to 220 volts A. C. ..... **MIZAB**  
 Holder for photomicrographs in transmitted light illumination  
 Holder for photomicrographs in incident light illumination

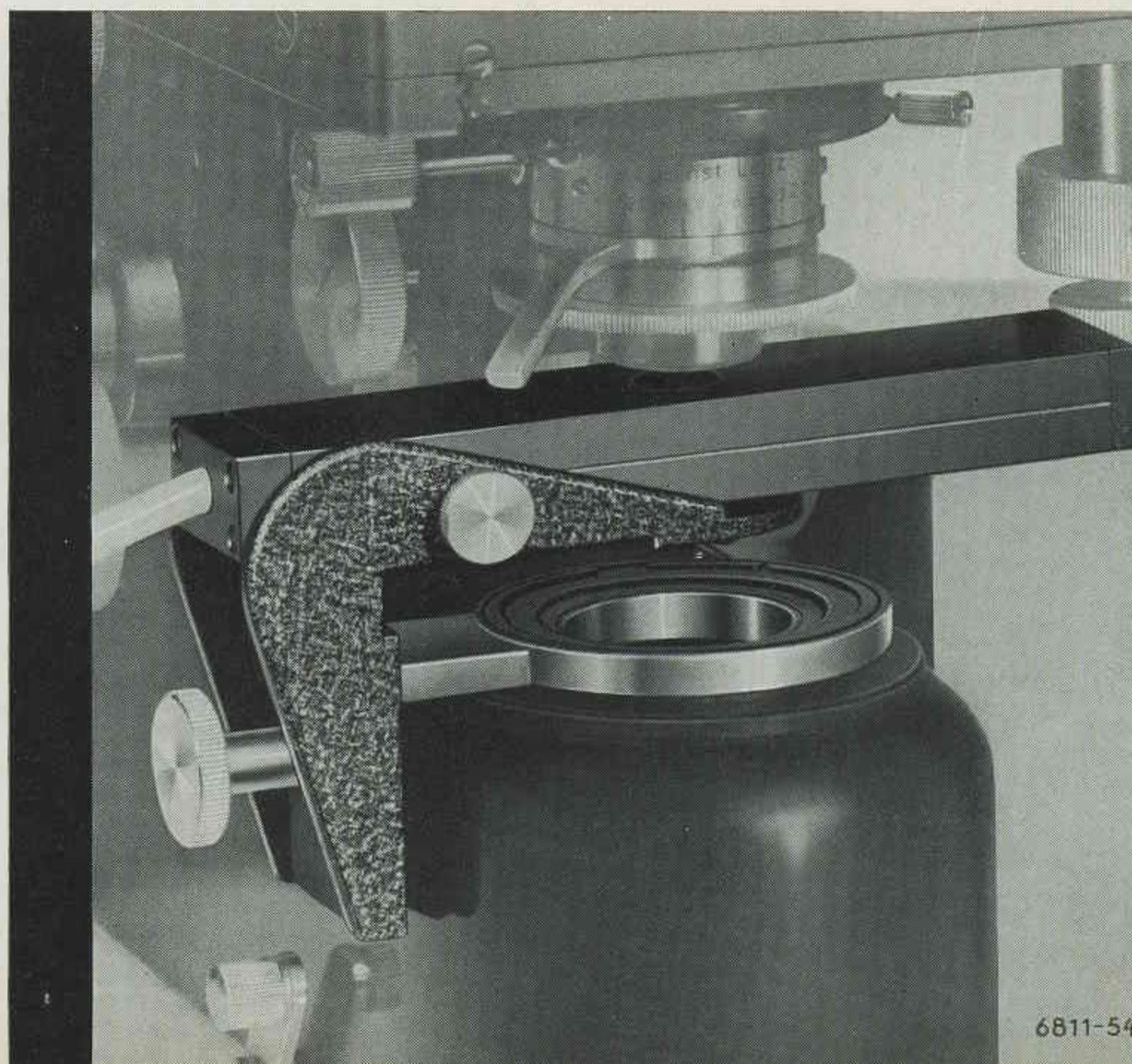

**ARISTOPHOT**  
**Universal Photographic Outfit**  
for macrophotography and photomicrography  
on plates 9x12 cm (3 1/4" x 4 1/4") or 35 mm film

ORTHOLUX with ARISTOPHOT equipped for photomicrography with a mirror reflex 9 x 12 cm bellows camera. The source of light shown here is the fluorescence twin lamp for examinations in transmitted, incident, or combined transmitted and incident fluorescent light.

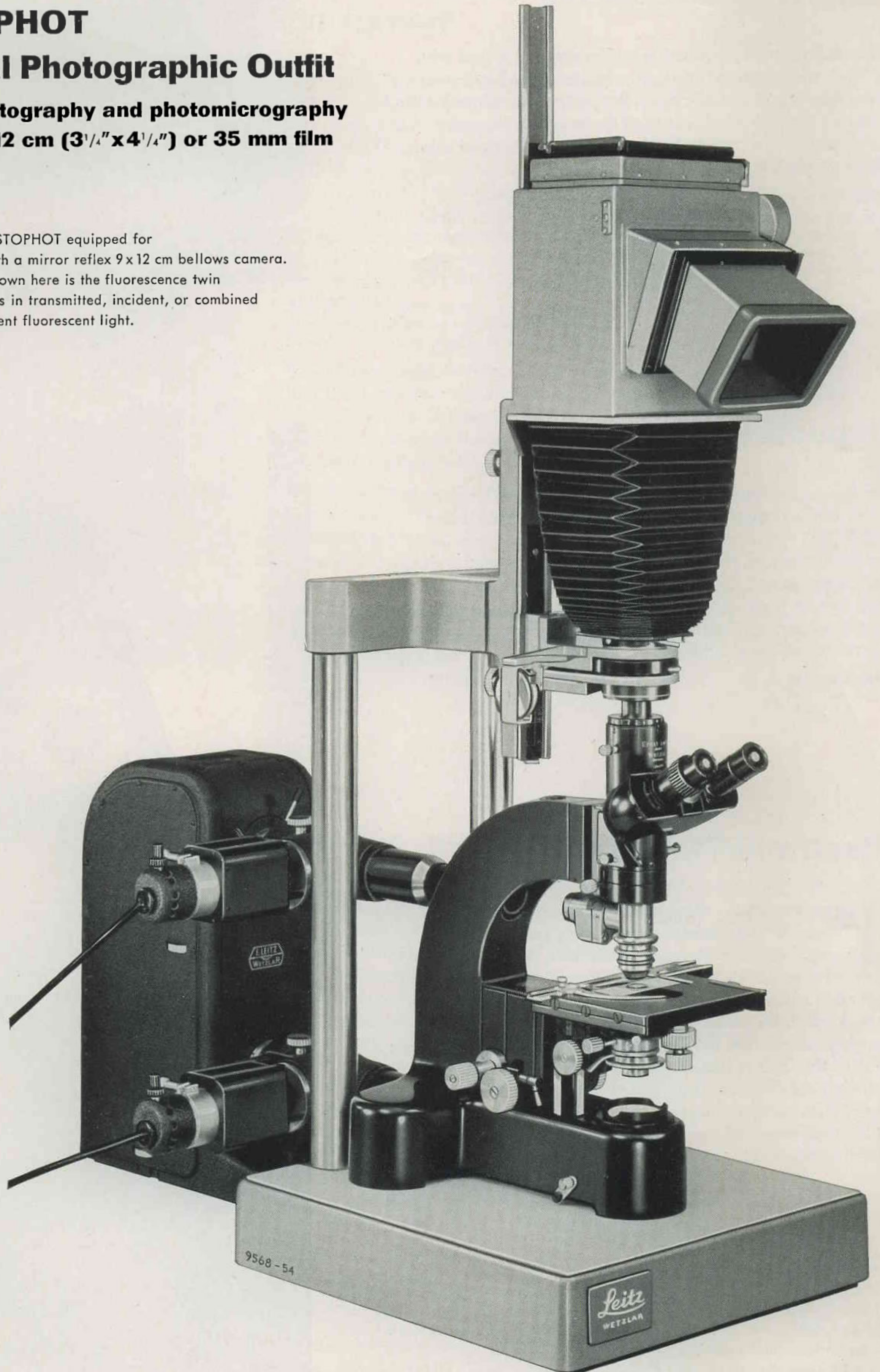

Practical microscopic work often requires an immediate documentary record through photomicrography. The ORTHOLUX universal microscope offers the best facilities particularly for this special field: the photo tube FS with binocular eyepieces offers all the advantages of binocular observation, combined with a simple switching device for transfer to photomicrography. A further advantage is to be seen in the non-deflected, i. e. direct beam path from the specimen to the film or plate. This eliminates unnecessary losses in light and possible centring errors; the image on the observation screen of the mirror reflex attachment is very bright. Thus ORTHOLUX and ARISTOPHOT form an ideal unit for macrophotography, general survey photography, and for photomicrography, and may be regarded as a universal photo microscope. All lamp attachments designed for photomicrography can be used with the ORTHOLUX-ARISTOPHOT combination. The microscope which is placed on the ARISTOPHOT and is orientated to the base plate, can be removed at any time.

The camera used can be either a flash synchronized bellows camera 9 x 12 cm (3 1/4" x 4 1/4") with mirror reflex attachment, or the LEICA 35 mm camera in combination with a mirror reflex attachment and the ground glass screen field enlarged by a magnifier. The LEICA system with its advantages as regards low cost of negative material and short times of exposure is particularly suitable for serial photomicrography and for colour work. General survey photographs with low magnifications, approximately in the range of 2:1 to 20:1 can be carried out with a special survey tube attachable to the ORTHOLUX.

- ARISTOPHOT with 9 x 12 cm mirror reflex bellows camera, complete outfit for photomicrography (without ORTHOLUX) .. MAAHG
- ARISTOPHOT for LEICA with micro mirror reflex attachment, complete outfit for photomicrography (without ORTHOLUX and LEICA) ..... MAALK
- General survey tube with wide aperture .. OPZOS
- Large-field condenser for same on interchange slide ..... OPWUP
- and coated 50 mm MILAR objective ..... PUZII
- Screw-on ring ..... OPZAN

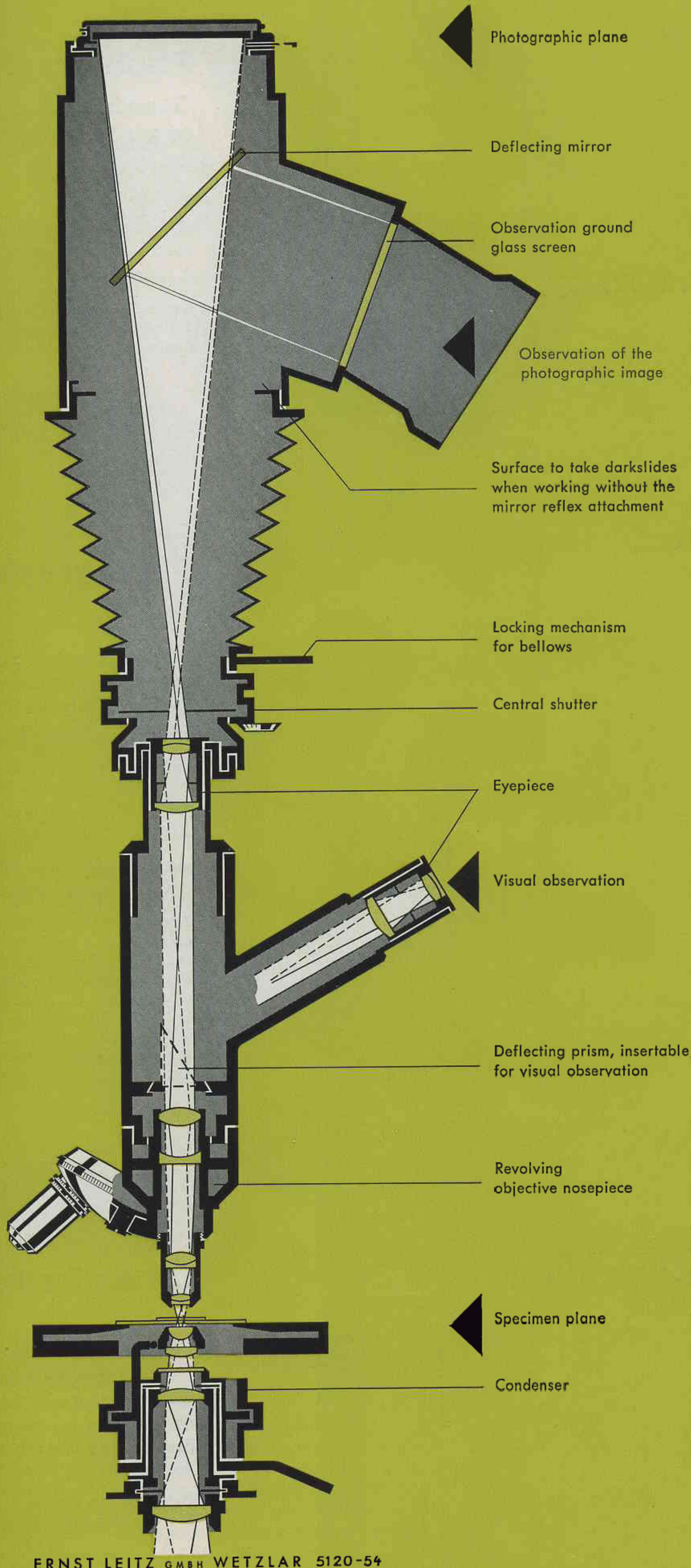

ERNST LEITZ GMBH WETZLAR 5120-54

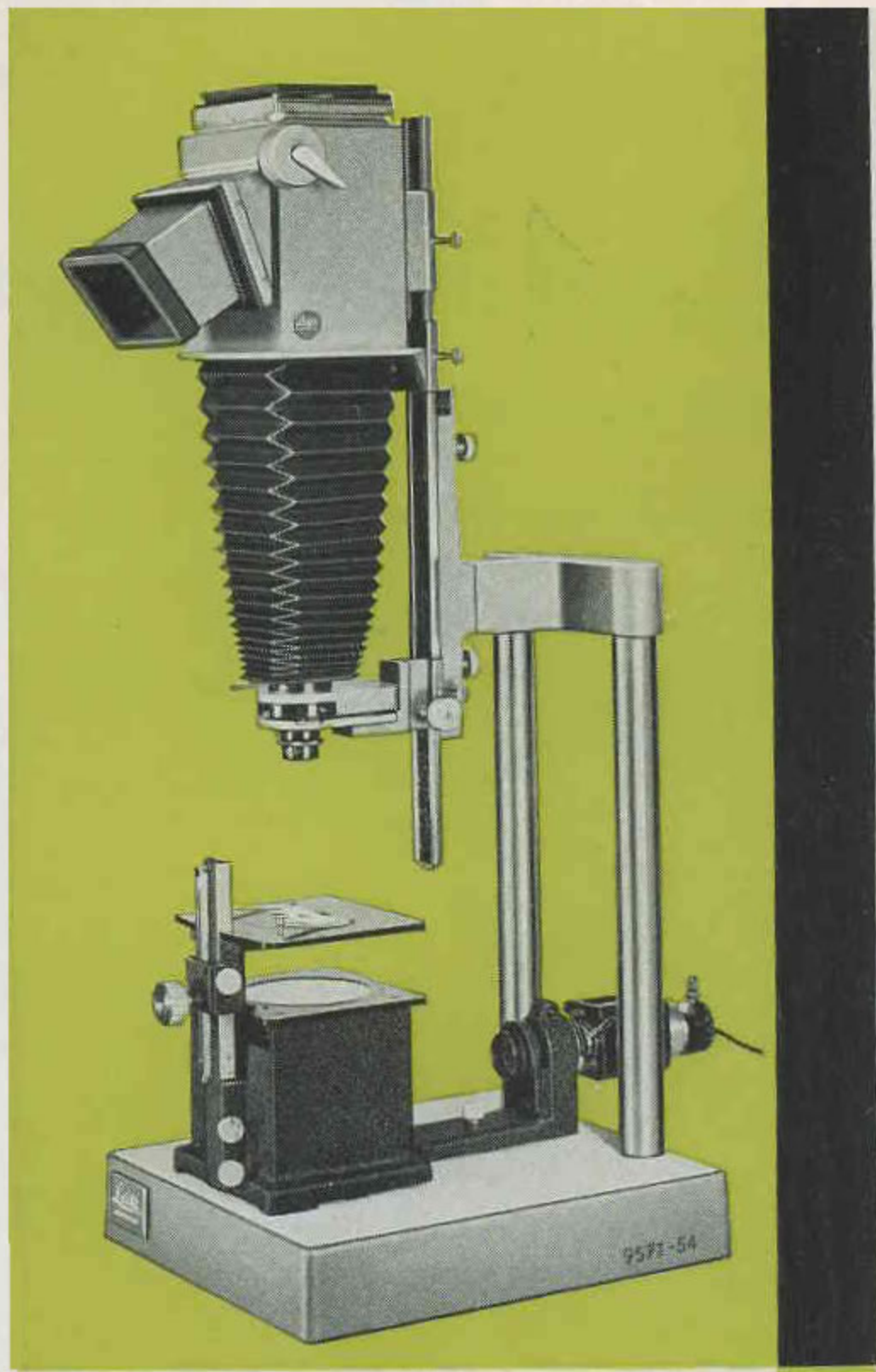

## Photography in Transmitted Light

**General survey photographs with specimen fields of up to 95 mm in diameter**

Large sections or other transparent specimens are fully illuminated by the macro-dia equipment with an effective object field of 95 mm diameter. A special model is available for polarized light.

Macro-dia equipment, complete with accessories  
but without low-voltage lamp ..... EEZYX  
Condenser lenses and diaphragm insets on request

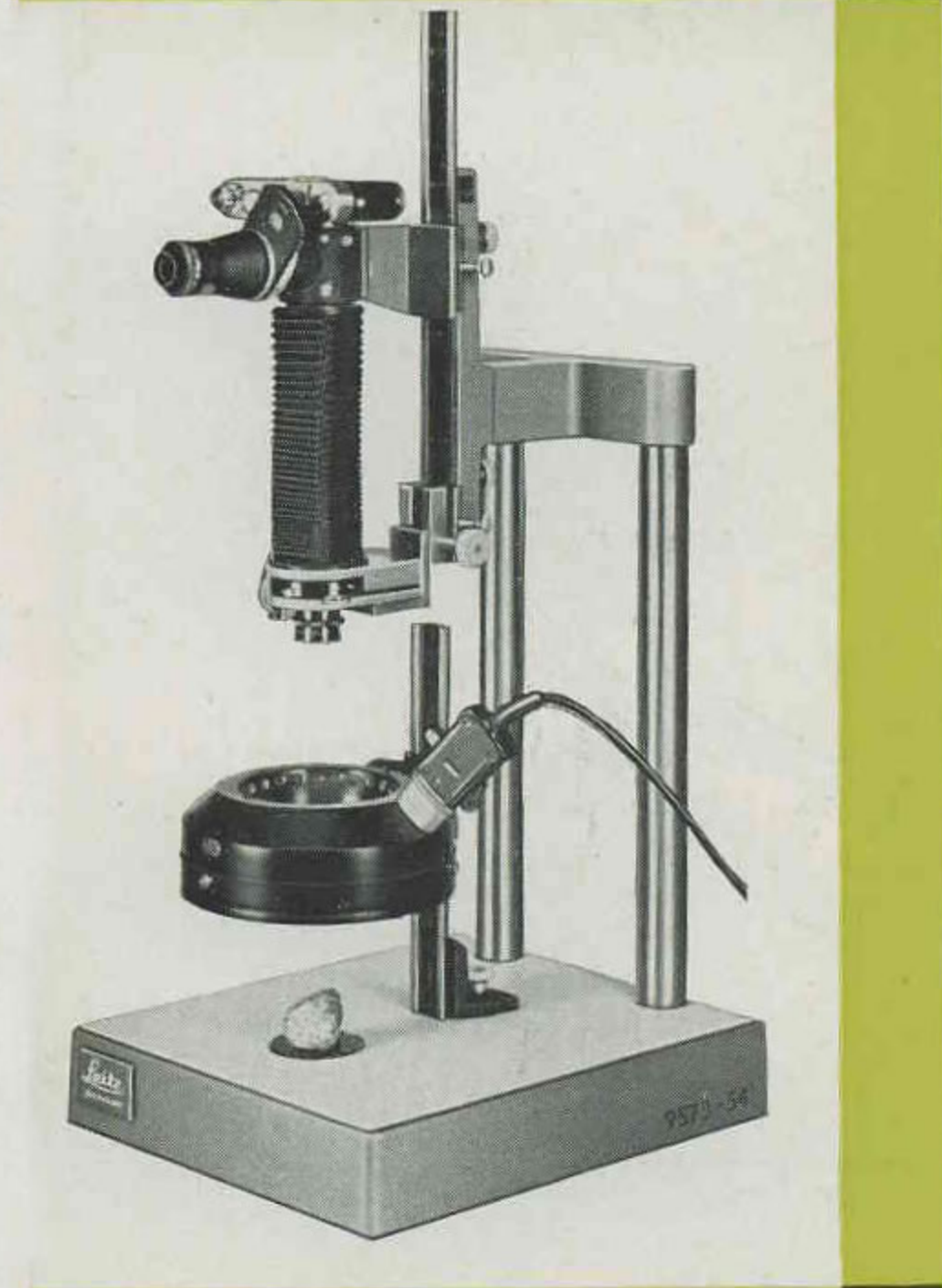

## Photography in Incident Light

In addition to the camera, the supplementary equipment necessary comprises lenses of the MILAR® or SUMMAR® type and an illuminating device. As a stage for the specimen, the base plate of the ARISTOPHOT is used. The scale obtainable lies between 1:5 and 30:1.

For illumination purposes, the macro ring illuminator is generally preferred. It illuminates the specimen uniformly from all sides, but for plastic effects the light can be partly blocked by the use of sector diaphragms.

Moving specimens can be photographed with the macro ring flash, which also contains an annular luminescent tube for focusing purposes.

Coated f/4.5 12 cm SUMMAR for macrophotography and general survey ....	SUMZO-RIING
Coated f/4.5 8 cm SUMMAR for macrophotography and general survey ....	SUMUR-RIING
Coated f/4.5 35 mm SUMMAR for macrophotography and general survey ....	SUMEX-RIING
Macro ring illuminator with accessories, ready for connection to 220 volts A. C. ....	GUHII
Macro ring flash including electrical accessories for connection to 220 volts A. C. ....	RIKIZ
Micro mirror reflex attachment for the LEICA, including extending bellows and lower camera bellows with shutter .....	IFLEX-EEXRL- EEXSN-ORHAL

© = Registered trade mark.

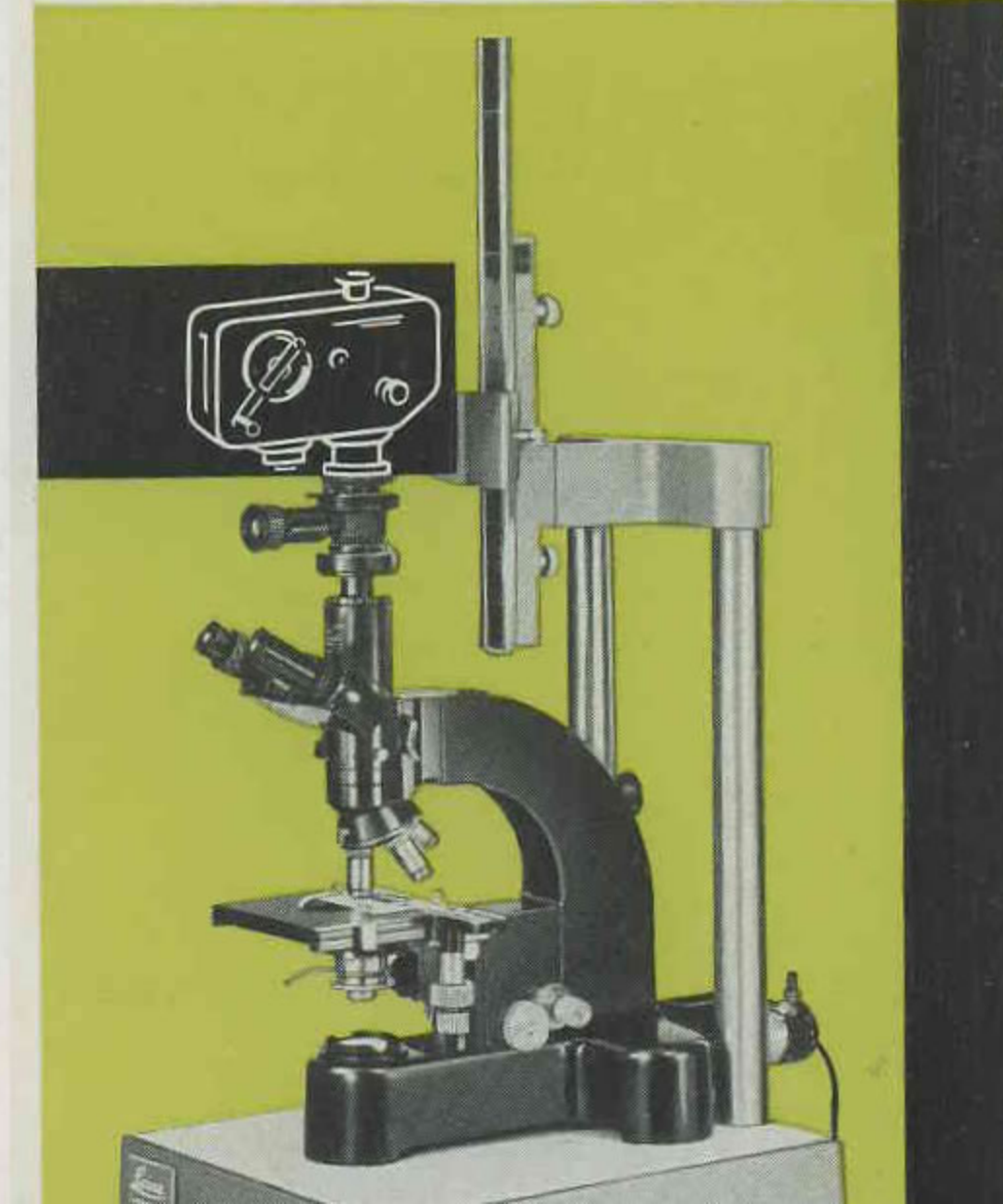

## Cinemicrography

Cinemicrography in all its variations is possible by using the ORTHOLUX in conjunction with the ARISTOPHOT camera stand. A focusing attachment and a holder for the substandard film camera are also required. For this type of work it is expedient to use the xenon lamp as the source of light.

Holder for film camera  
Focusing telescope with observation prism with 95% transmission ..... IQYGI



5098-94

Living *Trypanosoma gambiense* in mouse blood,  
phase contrast photomicrograph with 300 watt micro-flash.  
The parasites, which belong to the group of flagellates, can be distinguished  
by the flagella growing laterally from the cells in the form of narrow undulating  
membrane. The vibration of this vellum can only be observed in vivo,  
and can only be photographed by flash-light owing to the speed of movement.  
Objective Pv 90/1.15, periplanatic eyepiece 10x, MIKAS micro attachment  
for LEICA.. scale of 24x36 mm negative 375:1, subsequently enlarged to 2500:1.

## Our manufacturing programme includes:

Microscopes of modern design for general biological and medical examinations, metallography, mineralogy, ore microscopy, and coal petrography

Phase contrast equipment

Binocular prism magnifiers

Stereoscopic microscopes

Photomicrographic equipment

Microtomes

Micro-refractometers

Spectroscopes

Photometers for photometric and nephelometric determination of concentrations

Electro polarimeters

Monochromators

Infrared spectrographs

Optical material testing instruments such as hardness testers, heating microscopes, dilatometers, stress testing apparatus, etc.

Optical precision measuring instruments, such as workshop microscopes, profile projectors, instruments for measuring angles and lengths, reading and alignment telescopes

Prism binoculars

The LEICA 35 mm camera with its supplementary equipment for scientific and industrial photography, enlarging equipment, slide projectors, lecture-hall projectors, school epidiscopes, micro-projectors, 16 mm sound film projectors

Electros of the illustrations shown in our catalogues will be gladly supplied free of charge for publication in scientific journals.

The illustrations shown need not conform in every detail to equipment supplied by us, since we are continually modifying our instruments in order to keep in line with the very latest developments in research and instrument design.

**Leitz**  
WETZLAR

**ERNST LEITZ GMBH WETZLAR GERMANY**

Subsidiary: Ernst Leitz (Canada) Ltd., Midland, Ontario

U. S. Distributors: E. Leitz, Inc. 468 Park Ave. South New York 16, N.Y.

List **51<sub>2</sub>-40b/Engl.**

Printed in Germany  
X/60/LX/L.